

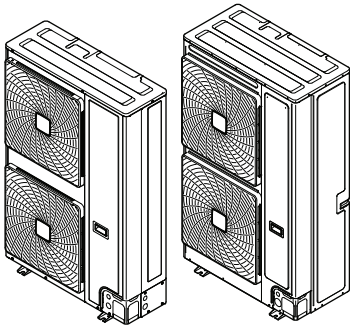

Installer and user reference guide  
VRV IV-S system air conditioner



RXYSQ8TMY1B  
RXYSQ10TMY1B  
RXYSQ12TMY1B

# Table of contents

<b>1</b>	<b>General safety precautions</b>	<b>6</b>
1.1	About the documentation.....	6
1.1.1	Meaning of warnings and symbols.....	6
1.2	For the user .....	7
1.3	For the installer .....	8
1.3.1	General.....	8
1.3.2	Installation site.....	9
1.3.3	Refrigerant — in case of R410A or R32.....	10
1.3.4	Brine .....	11
1.3.5	Water .....	12
1.3.6	Electrical.....	12
<b>2</b>	<b>About the documentation</b>	<b>15</b>
2.1	About this document.....	15
<b>For the installer</b>		<b>16</b>
<b>3</b>	<b>About the box</b>	<b>17</b>
3.1	Outdoor unit.....	17
3.1.1	To unpack the outdoor unit.....	17
3.1.2	To handle the outdoor unit .....	18
3.1.3	To remove the accessories from the outdoor unit.....	19
3.1.4	To remove the transportation stay .....	19
<b>4</b>	<b>About the units and options</b>	<b>21</b>
4.1	Identification .....	21
4.1.1	Identification label: Outdoor unit.....	21
4.2	About the outdoor unit.....	22
4.3	System layout .....	22
4.4	Combining units and options .....	22
4.4.1	About combining units and options .....	23
4.4.2	Possible combinations of indoor units .....	23
4.4.3	Possible options for the outdoor unit .....	23
<b>5</b>	<b>Preparation</b>	<b>25</b>
5.1	Preparing the installation site.....	25
5.1.1	Installation site requirements of the outdoor unit.....	25
5.1.2	Additional installation site requirements of the outdoor unit in cold climates .....	28
5.1.3	Securing safety against refrigerant leaks .....	29
5.2	Preparing refrigerant piping.....	31
5.2.1	Refrigerant piping requirements.....	31
5.2.2	Refrigerant piping material.....	32
5.2.3	To select the piping size.....	32
5.2.4	To select refrigerant branch kits .....	34
5.2.5	Refrigerant piping length and height difference.....	35
5.3	Preparing electrical wiring .....	38
5.3.1	About electrical compliance.....	38
5.3.2	Safety device requirements.....	38
<b>6</b>	<b>Installation</b>	<b>40</b>
6.1	Overview: Installation.....	40
6.2	Opening the units.....	41
6.2.1	About opening the units .....	41
6.2.2	To open the outdoor unit .....	41
6.3	Mounting the outdoor unit.....	42
6.3.1	About mounting the outdoor unit.....	42
6.3.2	Precautions when mounting the outdoor unit .....	42
6.3.3	To provide the installation structure.....	42
6.3.4	To install the outdoor unit.....	43
6.3.5	To provide drainage.....	43
6.3.6	To prevent the outdoor unit from falling over.....	44
6.4	Connecting the refrigerant piping.....	44
6.4.1	About connecting the refrigerant piping .....	44
6.4.2	Precautions when connecting the refrigerant piping .....	45
6.4.3	Pipe bending guidelines.....	45

6.4.4	To braze the pipe end.....	45
6.4.5	Using the stop valve and service port.....	46
6.4.6	To remove the pinched pipes.....	48
6.4.7	To connect the refrigerant piping to the outdoor unit.....	49
6.4.8	To connect the refrigerant branching kit.....	52
6.5	Checking the refrigerant piping.....	53
6.5.1	About checking the refrigerant piping.....	53
6.5.2	Checking refrigerant piping: General guidelines.....	54
6.5.3	Checking refrigerant piping: Setup.....	54
6.5.4	To perform a leak test.....	55
6.5.5	To perform vacuum drying.....	56
6.5.6	To insulate the refrigerant piping.....	56
6.6	Charging refrigerant.....	57
6.6.1	About charging refrigerant.....	57
6.6.2	Precautions when charging refrigerant.....	57
6.6.3	To determine the additional refrigerant amount.....	58
6.6.4	To charge refrigerant.....	59
6.6.5	Error codes when charging refrigerant.....	61
6.6.6	To fix the fluorinated greenhouse gases label.....	61
6.7	Connecting the electrical wiring.....	62
6.7.1	About connecting the electrical wiring.....	62
6.7.2	To connect the electrical wiring to the outdoor unit.....	67
6.8	Finishing the outdoor unit installation.....	70
6.8.1	To finish the interconnection wiring.....	70
6.8.2	To close the outdoor unit.....	70
<b>7</b>	<b>Configuration</b>	<b>71</b>
7.1	Making field settings.....	71
7.1.1	About making field settings.....	71
7.1.2	To access the field setting components.....	72
7.1.3	Field setting components.....	72
7.1.4	To access mode 1 or 2.....	74
7.1.5	To use mode 1.....	75
7.1.6	To use mode 2.....	76
7.1.7	Mode 1 (and default situation): Monitoring settings.....	77
7.1.8	Mode 2: field settings.....	80
7.1.9	To connect the PC configurator to the outdoor unit.....	84
7.2	Energy saving and optimum operation.....	84
7.2.1	Available main operation methods.....	85
7.2.2	Available comfort settings.....	86
7.2.3	Example: Automatic mode during cooling.....	88
7.2.4	Example: Automatic mode during heating.....	89
<b>8</b>	<b>Commissioning</b>	<b>91</b>
8.1	Overview: Commissioning.....	91
8.2	Precautions when commissioning.....	91
8.3	Checklist before commissioning.....	92
8.4	Checklist during commissioning.....	93
8.4.1	About the system test run.....	93
8.4.2	To perform a test run (7-LEDs display).....	94
8.4.3	To perform a test run (7-segment display).....	94
8.4.4	Correcting after abnormal completion of the test run.....	95
<b>9</b>	<b>Hand-over to the user</b>	<b>97</b>
<b>10</b>	<b>Maintenance and service</b>	<b>98</b>
10.1	Maintenance safety precautions.....	98
10.1.1	To prevent electrical hazards.....	98
10.2	Checklist for yearly maintenance of the outdoor unit.....	99
10.3	About service mode operation.....	99
10.3.1	To use vacuum mode.....	99
10.3.2	To recover refrigerant.....	100
<b>11</b>	<b>Troubleshooting</b>	<b>101</b>
11.1	Overview: Troubleshooting.....	101
11.2	Precautions when troubleshooting.....	101
11.3	Solving problems based on error codes.....	101
11.3.1	Error codes: Overview.....	102
<b>12</b>	<b>Disposal</b>	<b>107</b>

<b>13</b>	<b>Technical data</b>	<b>108</b>
13.1	Service space: Outdoor unit.....	109
13.2	Piping diagram: Outdoor unit.....	111
13.3	Wiring diagram: Outdoor unit.....	113
<b>For the user</b>		<b>118</b>
<b>14</b>	<b>About the system</b>	<b>119</b>
14.1	System layout.....	120
<b>15</b>	<b>User interface</b>	<b>121</b>
<b>16</b>	<b>Operation</b>	<b>122</b>
16.1	Before operation.....	122
16.2	Operation range.....	123
16.3	Operating the system.....	123
16.3.1	About operating the system.....	123
16.3.2	About cooling, heating, fan only, and automatic operation.....	123
16.3.3	About the heating operation.....	124
16.3.4	To operate the system.....	124
16.4	Using the dry program.....	125
16.4.1	About the dry program.....	125
16.4.2	To use the dry program.....	125
16.5	Adjusting the air flow direction.....	125
16.5.1	About the air flow flap.....	125
16.6	Setting the master user interface.....	126
16.6.1	About setting the master user interface.....	126
16.6.2	To designate the master user interface (VRV DX).....	127
16.6.3	To designate the master user interface (RA DX).....	127
16.6.4	About control systems.....	127
<b>17</b>	<b>Energy saving and optimum operation</b>	<b>128</b>
17.1	Available main operation methods.....	129
17.2	Available comfort settings.....	129
<b>18</b>	<b>Maintenance and service</b>	<b>130</b>
18.1	Maintenance after a long stop period.....	130
18.2	Maintenance before a long stop period.....	131
18.3	About the refrigerant.....	131
18.4	After-sales service and warranty.....	131
18.4.1	Warranty period.....	131
18.4.2	Recommended maintenance and inspection.....	132
18.4.3	Recommended maintenance and inspection cycles.....	132
18.4.4	Shortened maintenance and replacement cycles.....	133
<b>19</b>	<b>Troubleshooting</b>	<b>134</b>
19.1	Error codes: Overview.....	135
19.2	Symptoms that are NOT system malfunctions.....	137
19.2.1	Symptom: The system does not operate.....	138
19.2.2	Symptom: Fan operation is possible, but cooling and heating do not work.....	138
19.2.3	Symptom: The fan speed does not correspond to the setting.....	138
19.2.4	Symptom: The fan direction does not correspond to the setting.....	138
19.2.5	Symptom: White mist comes out of a unit (Indoor unit).....	138
19.2.6	Symptom: White mist comes out of a unit (Indoor unit, outdoor unit).....	138
19.2.7	Symptom: The user interface reads "U4" or "U5" and stops, but then restarts after a few minutes.....	139
19.2.8	Symptom: Noise of air conditioners (Indoor unit).....	139
19.2.9	Symptom: Noise of air conditioners (Indoor unit, outdoor unit).....	139
19.2.10	Symptom: Noise of air conditioners (Outdoor unit).....	139
19.2.11	Symptom: Dust comes out of the unit.....	139
19.2.12	Symptom: The units can give off odours.....	139
19.2.13	Symptom: The outdoor unit fan does not spin.....	139
19.2.14	Symptom: The display shows "88".....	140
19.2.15	Symptom: The compressor in the outdoor unit does not stop after a short heating operation.....	140
19.2.16	Symptom: The inside of an outdoor unit is warm even when the unit has stopped.....	140
19.2.17	Symptom: Hot air can be felt when the indoor unit is stopped.....	140
<b>20</b>	<b>Relocation</b>	<b>141</b>
<b>21</b>	<b>Disposal</b>	<b>142</b>











# 1 General safety precautions





## 1.1 About the documentation

- The original instructions are written in English. All other languages are translations of the original instructions.
- The precautions described in this document cover very important topics, follow them carefully.
- The installation of the system, and all activities described in the installation manual and in the installer reference guide **MUST** be performed by an authorised installer.



### 1.1.1 Meaning of warnings and symbols

	<b>DANGER</b> Indicates a situation that results in death or serious injury.
	<b>DANGER: RISK OF ELECTROCUTION</b> Indicates a situation that could result in electrocution.
	<b>DANGER: RISK OF BURNING/SCALDING</b> Indicates a situation that could result in burning/scalding because of extreme hot or cold temperatures.
	<b>DANGER: RISK OF EXPLOSION</b> Indicates a situation that could result in explosion.
	<b>WARNING</b> Indicates a situation that could result in death or serious injury.
	<b>WARNING: FLAMMABLE MATERIAL</b>
	<b>CAUTION</b> Indicates a situation that could result in minor or moderate injury.
	<b>NOTICE</b> Indicates a situation that could result in equipment or property damage.
	<b>INFORMATION</b> Indicates useful tips or additional information.

Symbols used on the unit:

Symbol	Explanation
	Before installation, read the installation and operation manual, and the wiring instruction sheet.
	Before performing maintenance and service tasks, read the service manual.
	For more information, see the installer and user reference guide.
	The unit contains rotating parts. Be careful when servicing or inspecting the unit.

Symbols used in the documentation:

Symbol	Explanation
	Indicates a figure title or a reference to it. <b>Example:</b> "▲ 1-3 Figure title" means "Figure 3 in chapter 1".
	Indicates a table title or a reference to it. <b>Example:</b> "■ 1-3 Table title" means "Table 3 in chapter 1".

## 1.2 For the user



### WARNING

If you are NOT sure how to operate the unit, contact your installer.



### WARNING

This appliance can be used by children aged from 8 years and above and persons with reduced physical, sensory or mental capabilities or lack of experience and knowledge if they have been given supervision or instruction concerning use of the appliance in a safe way and understand the hazards involved.

Children SHALL NOT play with the appliance.

Cleaning and user maintenance SHALL NOT be made by children without supervision.



### WARNING

To prevent electrical shocks or fire:

- Do NOT rinse the unit.
- Do NOT operate the unit with wet hands.
- Do NOT place any objects containing water on the unit.



### CAUTION

- Do NOT place any objects or equipment on top of the unit.
- Do NOT sit, climb or stand on the unit.

- Units are marked with the following symbol:



This means that electrical and electronic products may NOT be mixed with unsorted household waste. Do NOT try to dismantle the system yourself: dismantling the system, treatment of the refrigerant, of oil and of other parts MUST be done by an authorised installer and MUST comply with applicable legislation.

Units MUST be treated at a specialised treatment facility for reuse, recycling and recovery. By ensuring this product is disposed of correctly, you will help to prevent potential negative consequences for the environment and human health. For more information, contact your installer or local authority.

- Batteries are marked with the following symbol:



This means that the batteries may NOT be mixed with unsorted household waste. If a chemical symbol is printed beneath the symbol, this chemical symbol means that the battery contains a heavy metal above a certain concentration.

Possible chemical symbols are: Pb: lead (>0.004%).

Waste batteries MUST be treated at a specialised treatment facility for reuse. By ensuring waste batteries are disposed of correctly, you will help to prevent potential negative consequences for the environment and human health.

## 1.3 For the installer

### 1.3.1 General

If you are NOT sure how to install or operate the unit, contact your dealer.



### DANGER: RISK OF BURNING/SCALDING

- Do NOT touch the refrigerant piping, water piping or internal parts during and immediately after operation. It could be too hot or too cold. Give it time to return to normal temperature. If you MUST touch it, wear protective gloves.
- Do NOT touch any accidental leaking refrigerant.



### WARNING

Improper installation or attachment of equipment or accessories could result in electrical shock, short-circuit, leaks, fire or other damage to the equipment. ONLY use accessories, optional equipment and spare parts made or approved by Daikin unless otherwise specified.



**WARNING**

Make sure installation, testing and applied materials comply with applicable legislation (on top of the instructions described in the Daikin documentation).

**WARNING**

Tear apart and throw away plastic packaging bags so that nobody, especially children, can play with them. **Possible consequence:** suffocation.

**WARNING**

Provide adequate measures to prevent that the unit can be used as a shelter by small animals. Small animals that make contact with electrical parts can cause malfunctions, smoke or fire.

**CAUTION**

Wear adequate personal protective equipment (protective gloves, safety glasses,...) when installing, maintaining or servicing the system.

**CAUTION**

Do NOT touch the air inlet or aluminium fins of the unit.

**CAUTION**

- Do NOT place any objects or equipment on top of the unit.
- Do NOT sit, climb or stand on the unit.

**NOTICE**

Works executed on the outdoor unit are best done under dry weather conditions to avoid water ingress.

In accordance with the applicable legislation, it might be necessary to provide a logbook with the product containing at least: information on maintenance, repair work, results of tests, stand-by periods,...

Also, at least, following information **MUST** be provided at an accessible place at the product:

- Instructions for shutting down the system in case of an emergency
- Name and address of fire department, police and hospital
- Name, address and day and night telephone numbers for obtaining service

In Europe, EN378 provides the necessary guidance for this logbook.

### 1.3.2 Installation site

- Provide sufficient space around the unit for servicing and air circulation.
- Make sure the installation site withstands the weight and vibration of the unit.
- Make sure the area is well ventilated. Do NOT block any ventilation openings.
- Make sure the unit is level.

Do NOT install the unit in the following places:

- In potentially explosive atmospheres.

- In places where there is machinery that emits electromagnetic waves. Electromagnetic waves may disturb the control system, and cause malfunction of the equipment.
- In places where there is a risk of fire due to the leakage of flammable gases (example: thinner or gasoline), carbon fibre, ignitable dust.
- In places where corrosive gas (example: sulphurous acid gas) is produced. Corrosion of copper pipes or soldered parts may cause the refrigerant to leak.

### 1.3.3 Refrigerant — in case of R410A or R32

If applicable. See the installation manual or installer reference guide of your application for more information.



#### **DANGER: RISK OF EXPLOSION**

**Pump down – Refrigerant leakage.** If you want to pump down the system, and there is a leak in the refrigerant circuit:

- Do NOT use the unit's automatic pump down function, with which you can collect all refrigerant from the system into the outdoor unit. **Possible consequence:** Self-combustion and explosion of the compressor because of air going into the operating compressor.
- Use a separate recovery system so that the unit's compressor does NOT have to operate.



#### **WARNING**

During tests, NEVER pressurise the product with a pressure higher than the maximum allowable pressure (as indicated on the nameplate of the unit).



#### **WARNING**

Take sufficient precautions in case of refrigerant leakage. If refrigerant gas leaks, ventilate the area immediately. Possible risks:

- Excessive refrigerant concentrations in a closed room can lead to oxygen deficiency.
- Toxic gas might be produced if refrigerant gas comes into contact with fire.



#### **WARNING**

ALWAYS recover the refrigerant. Do NOT release them directly into the environment. Use a vacuum pump to evacuate the installation.



#### **WARNING**

Make sure there is no oxygen in the system. Refrigerant may ONLY be charged after performing the leak test and the vacuum drying.

**Possible consequence:** Self-combustion and explosion of the compressor because of oxygen going into the operating compressor.



#### **NOTICE**

- To avoid compressor breakdown, do NOT charge more than the specified amount of refrigerant.
- When the refrigerant system is to be opened, refrigerant MUST be treated according to the applicable legislation.



**NOTICE**



Make sure the field piping and connections are NOT subjected to stress.



**NOTICE**

After all the piping has been connected, make sure there is no gas leak. Use nitrogen to perform a gas leak detection.

- In case recharge is required, see the nameplate or the refrigerant charge label of the unit. It states the type of refrigerant and necessary amount.
- Whether the unit is factory charged with refrigerant or non-charged, in both cases you might need to charge additional refrigerant, depending on the pipe sizes and pipe lengths of the system.
- ONLY use tools exclusively for the refrigerant type used in the system, this to ensure pressure resistance and prevent foreign materials from entering into the system.
- Charge the liquid refrigerant as follows:

If	Then
A siphon tube is present (i.e., the cylinder is marked with "Liquid filling siphon attached")	Charge with the cylinder upright. 
A siphon tube is NOT present	Charge with the cylinder upside down. 

- Open refrigerant cylinders slowly.
- Charge the refrigerant in liquid form. Adding it in gas form may prevent normal operation.



**CAUTION**

When the refrigerant charging procedure is done or when pausing, close the valve of the refrigerant tank immediately. If the valve is NOT closed immediately, remaining pressure might charge additional refrigerant. **Possible consequence:** Incorrect refrigerant amount.

1.3.4 Brine

If applicable. See the installation manual or installer reference guide of your application for more information.



**WARNING**

The selection of the brine MUST be in accordance with the applicable legislation.



**WARNING**

Take sufficient precautions in case of brine leakage. If brine leaks, ventilate the area immediately and contact your local dealer.



### WARNING

The ambient temperature inside the unit can get much higher than that of the room, e.g. 70°C. In case of a brine leak, hot parts inside the unit can create a hazardous situation.



### WARNING

The use and installation of the application **MUST** comply with the safety and environmental precautions specified in the applicable legislation.

### 1.3.5 Water

If applicable. See the installation manual or installer reference guide of your application for more information.



### NOTICE

Make sure water quality complies with EU directive 2020/2184.

### 1.3.6 Electrical



### DANGER: RISK OF ELECTROCUTION

- Turn OFF all power supply before removing the switch box cover, connecting electrical wiring or touching electrical parts.
- Disconnect the power supply for more than 10 minutes, and measure the voltage at the terminals of main circuit capacitors or electrical components before servicing. The voltage **MUST** be less than 50 V DC before you can touch electrical components. For the location of the terminals, see the wiring diagram.
- Do NOT touch electrical components with wet hands.
- Do NOT leave the unit unattended when the service cover is removed.



### WARNING

If NOT factory installed, a main switch or other means for disconnection, having a contact separation in all poles providing full disconnection under overvoltage category III condition, **MUST** be installed in the fixed wiring.

**WARNING**

- ONLY use copper wires.
- Make sure the field wiring complies with the national wiring regulations.
- All field wiring MUST be performed in accordance with the wiring diagram supplied with the product.
- NEVER squeeze bundled cables and make sure they do NOT come in contact with the piping and sharp edges. Make sure no external pressure is applied to the terminal connections.
- Make sure to install earth wiring. Do NOT earth the unit to a utility pipe, surge absorber, or telephone earth. Incomplete earth may cause electrical shock.
- Make sure to use a dedicated power circuit. NEVER use a power supply shared by another appliance.
- Make sure to install the required fuses or circuit breakers.
- Make sure to install an earth leakage protector. Failure to do so may cause electrical shock or fire.
- When installing the earth leakage protector, make sure it is compatible with the inverter (resistant to high frequency electric noise) to avoid unnecessary opening of the earth leakage protector.

**WARNING**

- After finishing the electrical work, confirm that each electrical component and terminal inside the switch box is connected securely.
- Make sure all covers are closed before starting up the unit.

**CAUTION**

- When connecting the power supply: connect the earth cable first, before making the current-carrying connections.
- When disconnecting the power supply: disconnect the current-carrying cables first, before separating the earth connection.
- The length of the conductors between the power supply stress relief and the terminal block itself MUST be as such that the current-carrying wires are tightened before the earth wire is in case the power supply is pulled loose from the stress relief.

**NOTICE**

Precautions when laying power wiring:



- Do NOT connect wiring of different thicknesses to the power terminal block (slack in the power wiring may cause abnormal heat).
- When connecting wiring which is the same thickness, do as shown in the figure above.
- For wiring, use the designated power wire and connect firmly, then secure to prevent outside pressure being exerted on the terminal board.
- Use an appropriate screwdriver for tightening the terminal screws. A screwdriver with a small head will damage the head and make proper tightening impossible.
- Over-tightening the terminal screws may break them.

Install power cables at least 1 meter away from televisions or radios to prevent interference. Depending on the radio waves, a distance of 1 meter may NOT be sufficient.

**NOTICE**

ONLY applicable if the power supply is three-phase, and the compressor has an ON/OFF starting method.

If there exists the possibility of reversed phase after a momentary black out and the power goes ON and OFF while the product is operating, attach a reversed phase protection circuit locally. Running the product in reversed phase can break the compressor and other parts.

## 2 About the documentation

### 2.1 About this document

#### Target audience

Authorised installers + end users



#### INFORMATION

This appliance is intended to be used by expert or trained users in shops, in light industry and on farms, or for commercial use by lay persons.

#### Documentation set

This document is part of a documentation set. The complete set consists of:

- **General safety precautions:**

- Safety instructions that you must read before installing
- Format: paper (in the box of the outdoor unit)

- **Outdoor unit installation and operation manual:**

- Installation and operation instructions
- Format: paper (in the box of the outdoor unit)

- **Installer and user reference guide:**

- Preparation of the installation, reference data,...
- Detailed step-by-step instructions and background information for basic and advanced usage
- Format: Digital files on <https://www.daikin.eu>. Use the search function 🔍 to find your model.

The latest revision of the supplied documentation is published on the regional Daikin website and is available via your dealer.

The original instructions are written in English. All other languages are translations of the original instructions.

#### Technical engineering data

- A **subset** of the latest technical data is available on the regional Daikin website (publicly accessible).
- The **full set** of the latest technical data is available on the Daikin Business Portal (authentication required).

For the installer



## 3 About the box

Keep the following in mind:

- At delivery, the unit **MUST** be checked for damage and completeness. Any damage or missing parts **MUST** be reported immediately to the claims agent of the carrier.
- Bring the packed unit as close as possible to its final installation position to prevent damage during transport.
- Prepare in advance the path along which you want to bring the unit to its final installation position.
- When handling the unit, take into account the following:



Fragile, handle the unit with care.



Keep the unit upright in order to avoid compressor damage.

### 3.1 Outdoor unit

#### 3.1.1 To unpack the outdoor unit

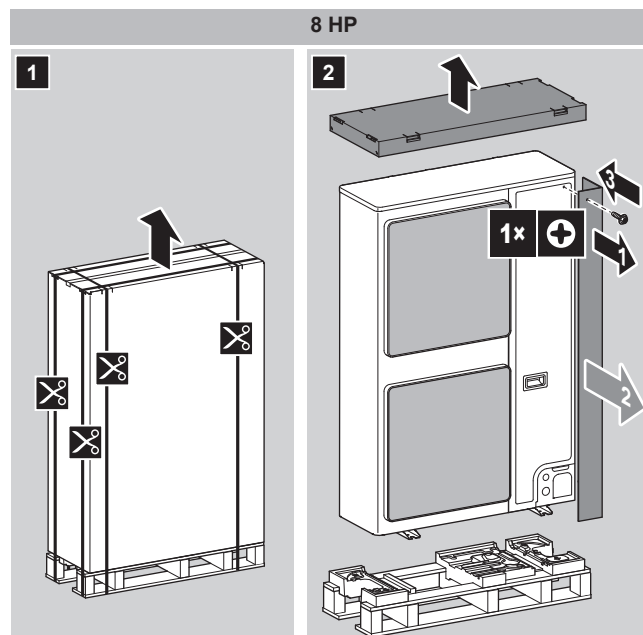

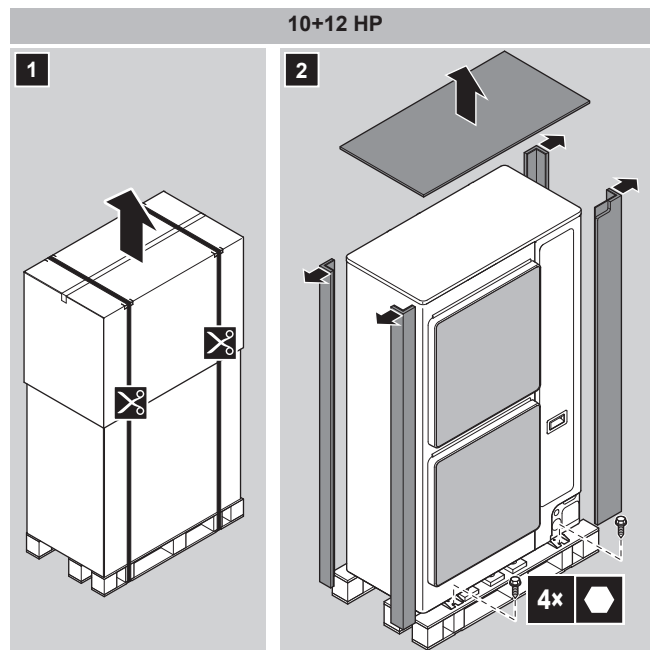

### 3.1.2 To handle the outdoor unit



#### CAUTION

To avoid injury, do NOT touch the air inlet or aluminium fins of the unit.

**Forklift.** If the unit remains on its pallet, you can also use a forklift.

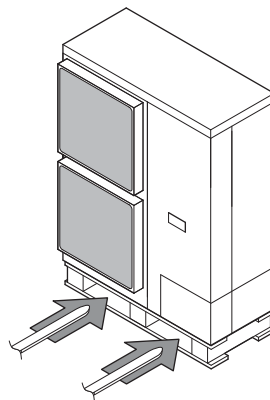

**Crane.** For 10+12 HP models, you can also use a crane and lift the unit as follows:

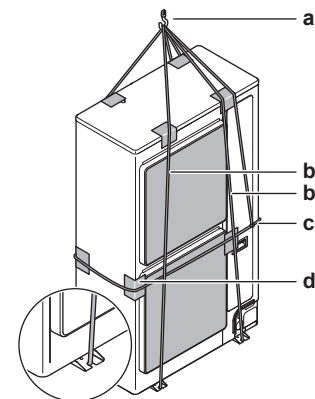

- a Lifting hook
- b Two vertical ropes (at least 8 m and  $\varnothing 20$  mm) to lift the unit
- c One horizontal rope (also fixed to the lifting hook) to prevent the unit from dropping
- d Protective material (rags, soft material) between the ropes and the casing to protect the casing



#### WARNING

The unit's center of gravity deviates to the right side (compressor side). If you lift the unit using a crane and you do not fix a horizontal rope to the lifting hook as shown, the unit might drop.

Carry the unit slowly as shown:

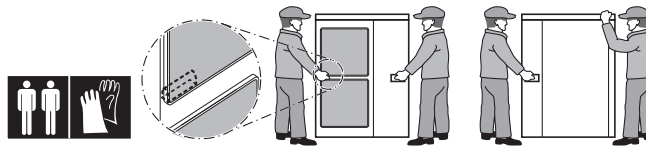

### 3.1.3 To remove the accessories from the outdoor unit

- 1 Remove the service cover. See "6.2.2 To open the outdoor unit" [▶ 41].
- 2 Remove the accessories.

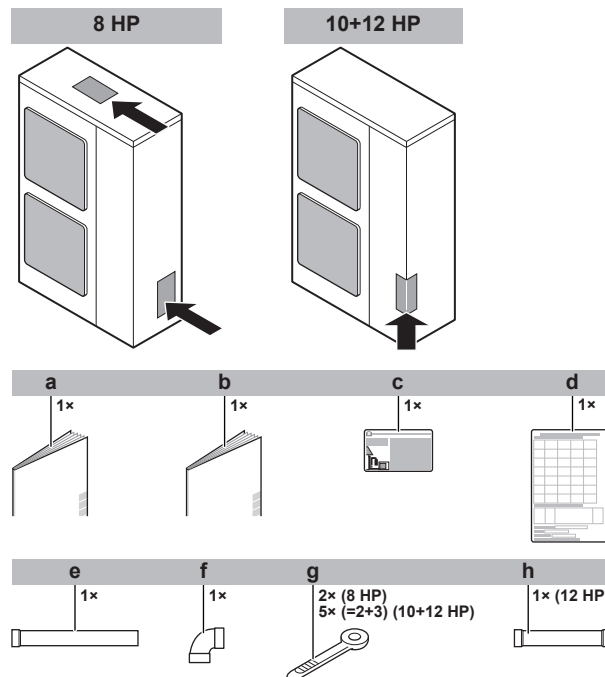

- a General safety precautions
- b Outdoor unit installation and operation manual
- c Fluorinated greenhouse gases label
- d Installation information sticker
- e Gas piping accessory 1 (8 HP:  $\varnothing 19.1$  mm; 10 HP:  $\varnothing 22.2$  mm; 12 HP:  $\varnothing 25.4$  mm)
- f Gas piping accessory 2 (8 HP:  $\varnothing 19.1$  mm; 10 HP:  $\varnothing 22.2$  mm; 12 HP:  $\varnothing 25.4$  mm)
- g Cable tie
- h Gas piping accessory 3 (12 HP:  $\varnothing 25.4$  mm to  $\varnothing 28.6$  mm)

### 3.1.4 To remove the transportation stay

Only for RXYSQ10+12.



#### NOTICE

If the unit is operated with the transportation stay attached, abnormal vibration or noise may be generated.

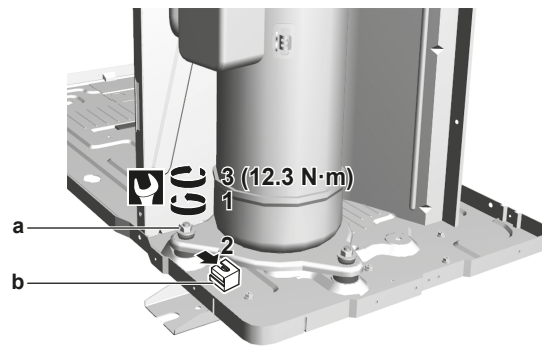

# 4 About the units and options

In this chapter

4.1	Identification.....	21
4.1.1	Identification label: Outdoor unit.....	21
4.2	About the outdoor unit.....	22
4.3	System layout.....	22
4.4	Combining units and options.....	22
4.4.1	About combining units and options.....	23
4.4.2	Possible combinations of indoor units.....	23
4.4.3	Possible options for the outdoor unit.....	23

## 4.1 Identification



### NOTICE

When installing or servicing several units at the same time, make sure NOT to switch the service panels between different models.

### 4.1.1 Identification label: Outdoor unit

#### Location

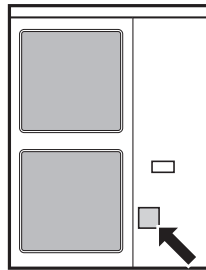

#### Model identification

**Example:** R X Y S Q 12 TM Y1 B [\*]

Code	Explanation
R	Outdoor air cooled
X	Heat pump (no continuous heating)
Y	Single module
S	S series
Q	Refrigerant R410A
8~12	Capacity class
TM	VRV IV series
Y1	Power supply
B	European market
[*]	Minor model change indication

## 4.2 About the outdoor unit

This installation manual concerns the VRV IV-S, full inverter driven, heat pump system.

These units are intended for outdoor installation and aimed for air to air heat pump applications.

Specification		RXYSQ8~12
Capacity	Heating	25.0~37.5 kW
	Cooling	22.4~33.5 kW
Ambient design temperature	Heating	-20~15.5°C WB
	Cooling	-5~52°C DB

## 4.3 System layout



### INFORMATION

The following figure is an example and may NOT completely match your system layout.



### INFORMATION

Not all combinations of indoor units are allowed, for guidance, see "[4.4.2 Possible combinations of indoor units](#)" [▶ 23].

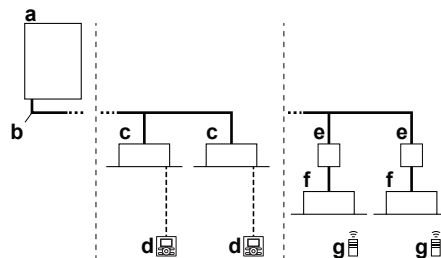

- a VRV IV-S Heat pump outdoor unit
- b Refrigerant piping
- c VRV direct expansion (DX) indoor unit
- d User interface (dedicated depending on indoor unit type)
- e BP box (required to connect Residential Air (RA) or Sky Air (SA) direct expansion (DX) indoor units)
- f Residential Air (RA) direct expansion (DX) indoor units
- g User interface (wireless, dedicated depending on indoor unit type)

## 4.4 Combining units and options



### INFORMATION

Certain options may NOT be available in your country.

## 4.4.1 About combining units and options

**NOTICE**

To be sure your system setup (outdoor unit+indoor unit(s)) will work, you have to consult the latest technical engineering data for the VRV heat pump.

The VRV IV-S heat pump system can be combined with several types of indoor units and is intended for R410A use only.

For an overview which units are available you can consult the product catalogue for VRV IV-S.

An overview is given indicating the allowed combinations of indoor units and outdoor units. Not all combinations are allowed. They are subject to rules (combination between outdoor-indoor, combinations between indoor units, etc.) mentioned in the technical engineering data.

## 4.4.2 Possible combinations of indoor units

In general following type of indoor units can be connected to a VRV heat pump system. The list is non-exhaustive and is depending on both outdoor unit model and indoor unit model combinations.

- VRV direct expansion (DX) indoor units (air to air applications).
- SA/RA (Sky Air/Residential Air) direct expansion (DX) indoor units (air to air applications). Further referred to as RA DX indoor units. These indoor units require a BP box.
- AHU (air to air applications): one of the following two combinations must be installed:
  - EKEXV-kit + EKEQ-box.
  - EKEXVA-kit + EKEACBVE-box.
- Air curtain (air to air applications): See the combination table in the databook for more information.

**INFORMATION**

- Combination of VRV DX and RA DX indoor units is not allowed.
- Combination of RA DX and AHU indoor units is not allowed.
- Combination of RA DX and air curtain indoor units is not allowed.

## 4.4.3 Possible options for the outdoor unit

**INFORMATION**

Refer to the technical engineering data for the latest option names.

**Refrigerant branching kit**

Description	Model name
Refnet header	KHRQ22M29H
	KHRQ22M64H

Description	Model name
Refnet joint	KHRQ22M20TA
	KHRQ22M29T9
	KHRQ22M64T

For the selection of the optimal branching kit, please refer to "5.2.4 To select refrigerant branch kits" [▶ 34].

#### External control adaptor (DTA104A61/62)

To instruct specific operation with an external input coming from a central control the external control adaptor can be used. Instructions (group or individual) can be instructed for low noise operation and power consumption limitation operation.

The external control adapter has to be installed in the indoor unit.

#### PC configurator cable (EKPCAB\*)

You can make several commissioning field settings through a personal computer interface. For this option EKPCAB\* is required which is a dedicated cable to communicate with the outdoor unit. The user interface software is available on <http://www.daikineurope.com/support-and-manuals/software-downloads/>.



# 5 Preparation

## In this chapter

5.1	Preparing the installation site .....	25
5.1.1	Installation site requirements of the outdoor unit .....	25
5.1.2	Additional installation site requirements of the outdoor unit in cold climates .....	28
5.1.3	Securing safety against refrigerant leaks.....	29
5.2	Preparing refrigerant piping.....	31
5.2.1	Refrigerant piping requirements .....	31
5.2.2	Refrigerant piping material.....	32
5.2.3	To select the piping size.....	32
5.2.4	To select refrigerant branch kits.....	34
5.2.5	Refrigerant piping length and height difference.....	35
5.3	Preparing electrical wiring.....	38
5.3.1	About electrical compliance .....	38
5.3.2	Safety device requirements.....	38

## 5.1 Preparing the installation site

Choose an installation location with sufficient space to transport the unit in and out of the site.

Do NOT install the unit in places often used as work place. In case of construction works (e.g. grinding works) where a lot of dust is created, the unit MUST be covered.

### 5.1.1 Installation site requirements of the outdoor unit



#### INFORMATION

Also read the following requirements:

- General installation site requirements. See the "General safety precautions" chapter.
- Service space requirements. See the "Technical data" chapter.
- Refrigerant piping requirements (length, height difference). See further in this "Preparation" chapter.



#### CAUTION

Appliance is NOT accessible to the general public. Install it in a secured area, protected from easy access.

This unit is suitable for installation in a commercial and light industrial environment.



#### NOTICE

This is a class A product. In a domestic environment this product may cause radio interference in which case the user may be required to take adequate measures.

**NOTICE**

The equipment described in this manual may cause electronic noise generated from radio-frequency energy. The equipment complies with specifications that are designed to provide reasonable protection against such interference. However, there is no guarantee that interference will not occur in a particular installation.

It is therefore recommended to install the equipment and electric wires in such a way that they keep a proper distance from stereo equipment, personal computers, etc.

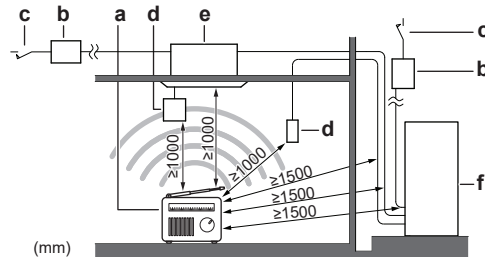

(mm)

- a Personal computer or radio
- b Fuse
- c Earth leakage protector
- d User interface
- e Indoor unit
- f Outdoor unit

- In places with weak reception, keep distances of 3 m or more to avoid electromagnetic disturbance of other equipment and use conduit tubes for power and transmission lines.
- Select a place where rain can be avoided as much as possible.
- Ensure that in the event of a water leak, no damage occurs to the installation space or its surroundings.
- Choose a location where the operation noise or the hot/cold air discharged from the unit will not disturb anyone and the location is selected according the applicable legislation.
- Heat exchanger fins are sharp and injury is possible. Choose an installation location where there is no risk for injury (especially in areas where children play).

Do NOT install the unit in the following places:

- Sound sensitive areas (e.g. near a bedroom), so that the operation noise will cause no trouble.

**Note:** If the sound is measured under actual installation conditions, the measured value might be higher than the sound pressure level mentioned in Sound spectrum in the data book due to environmental noise and sound reflections.

- In places where a mineral oil mist, spray or vapour may be present in the atmosphere. Plastic parts may deteriorate and fall off or cause water leakage.

It is NOT recommended to install the unit in the following places because it may shorten the life of the unit:

- Where the voltage fluctuates a lot
- In vehicles or vessels
- Where acidic or alkaline vapour is present

**Seaside installation.** Make sure the outdoor unit is NOT directly exposed to sea winds. This is to prevent corrosion caused by high levels of salt in the air, which might shorten the life of the unit.

Install the outdoor unit away from direct sea winds.

**Example:** Behind the building.

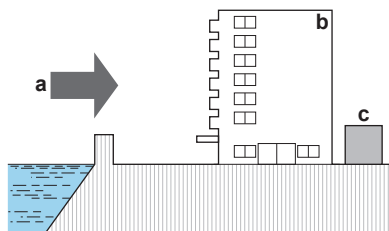

If the outdoor unit is exposed to direct sea winds, install a windbreaker.

- Height of windbreaker  $\geq 1.5 \times$  height of outdoor unit
- Mind the service space requirements when installing the windbreaker.

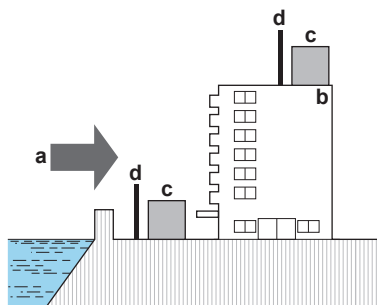

- a** Sea wind
- b** Building
- c** Outdoor unit
- d** Windbreaker

Strong winds ( $\geq 18$  km/h) blowing against the outdoor unit's air outlet causes short circuit (suction of discharge air). This may result in:

- deterioration of the operational capacity;
- frequent frost acceleration in heating operation;
- disruption of operation due to decrease of low pressure or increase of high pressure;
- a broken fan (if a strong wind blows continuously on the fan, it may start rotating very fast, until it breaks).

It is recommended to install a baffle plate when the air outlet is exposed to wind.

Turn the air outlet side towards the building's wall, fence or screen.

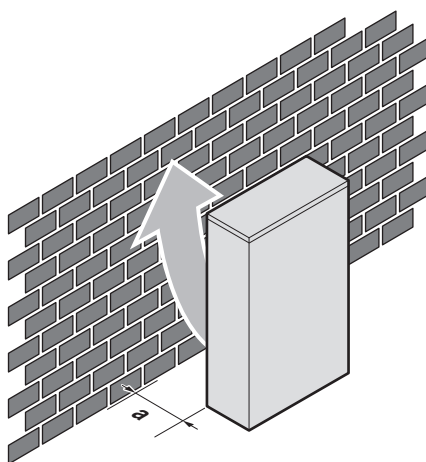

- a** Make sure there is enough installation space

Set the air outlet side at a right angle to the direction of the wind.

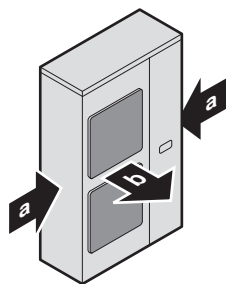

- a** Prevailing wind direction
- b** Air outlet

### 5.1.2 Additional installation site requirements of the outdoor unit in cold climates

Protect the outdoor unit against direct snowfall and take care that the outdoor unit is NEVER snowed up.

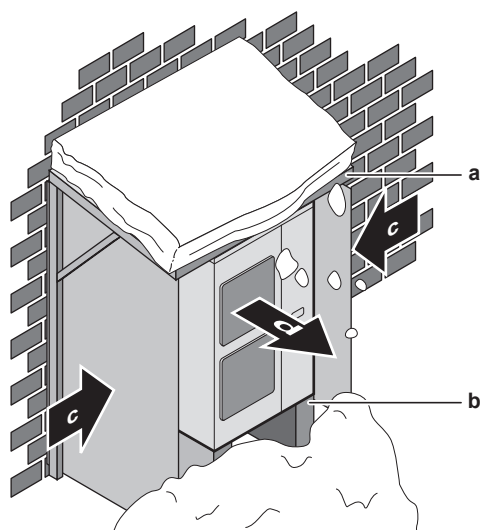

- a** Snow cover or shed
- b** Pedestal (minimum height = 150 mm)
- c** Prevailing wind direction
- d** Air outlet

**NOTICE**

When operating the unit **in heating** in a low outdoor ambient temperature with high humidity conditions, make sure to take precautions to keep the drain holes of the unit free by using proper equipment.

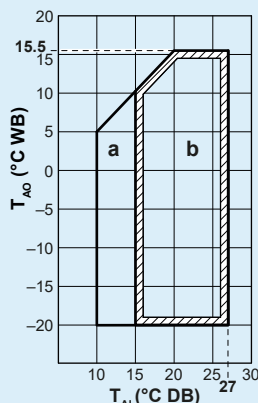

**a:** Warming up operation range; **b:** Heating operation range;  $T_{Ai}$ : Ambient indoor temperature;  $T_{Ao}$ : Ambient outdoor temperature

If the unit is selected to operate at ambient temperatures lower than  $-5^{\circ}\text{C}$  for 5 days or longer, with relative humidity levels exceeding 95%, we recommend to apply a Daikin range specifically designed for such application and/or to contact your dealer for further advice.

### 5.1.3 Securing safety against refrigerant leaks

#### About safety against refrigerant leaks

The installer and system specialist shall secure safety against leakage according to local regulations or standards. The following standards may be applicable if local regulations are not available.

This system uses R410A as refrigerant. R410A itself is an entirely safe non-toxic, non-combustible refrigerant. Nevertheless care must be taken to ensure that the system is installed in a room which is sufficiently large. This assures that the maximum concentration level of refrigerant gas is not exceeded, in the unlikely event of major leak in the system and this in accordance to the local applicable regulations and standards.

#### About the maximum concentration level

The maximum charge of refrigerant and the calculation of the maximum concentration of refrigerant is directly related to the humanly occupied space in to which it could leak.

The unit of measurement of the concentration is  $\text{kg}/\text{m}^3$  (the weight in kg of the refrigerant gas in  $1 \text{ m}^3$  volume of the occupied space).

Compliance to the local applicable regulations and standards for the maximum allowable concentration level is required.

According to the appropriate European Standard, the maximum allowed concentration level of refrigerant to a humanly space for R410A is limited to  $0.44 \text{ kg}/\text{m}^3$ .

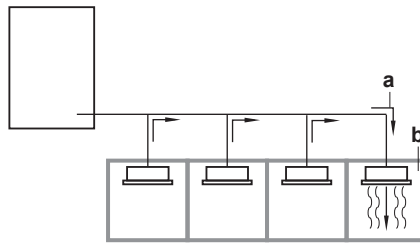

- a** Direction of the refrigerant flow
- b** Room where refrigerant leak has occurred (outflow of all the refrigerant from the system)

Pay special attention to places, such as basements etc., where refrigerant can stay, because refrigerant is heavier than air.

**To check the maximum concentration level**

Check the maximum concentration level in accordance with steps 1 to 4 below and take whatever action is necessary to comply.

- 1** Calculate the amount of refrigerant (kg) charged to each system separately.

Formula	A+B=C
A	Amount of refrigerant in a single unit system (amount of refrigerant with which the system is charged before leaving the factory)
B	Additional charging amount (amount of refrigerant added locally)
C	Total amount of refrigerant (kg) in the system



**NOTICE**

Where a single refrigerant facility is divided into 2 entirely independent refrigerant systems, use the amount of refrigerant with which each separate system is charged.

- 2** Calculate the volume of the room (m<sup>3</sup>) where the indoor unit is installed. In a case such as the following, calculate the volume of (D), (E) as a single room or as the smallest room.

**D** When there are no smaller room divisions:

E When there is a room division that has an opening sufficiently large to permit free air flow.

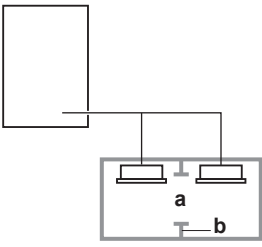

**a** Opening between the rooms. In case there is a door the openings above and below the door each must be equivalent in size to 0.15% or more of the floor area.

**b** Room division

- 3 Calculate the refrigerant density using the results of the calculations in steps 1 and 2 above. If the result of the above calculation exceeds the maximum concentration level, a ventilation opening to the adjacent room shall be made.

Formula	$F/G \leq H$
F	Total volume of refrigerant in the refrigerant system
G	Size (m <sup>3</sup> ) of smallest room in which there is an indoor unit installed
H	Maximum concentration level (kg/m <sup>3</sup> )

- 4 Calculate the refrigerant density taking the volume of the room where the indoor unit is installed and the adjacent room. Install ventilation openings in the door of adjacent rooms until the refrigerant density is smaller than the maximum concentration level.

## 5.2 Preparing refrigerant piping

### 5.2.1 Refrigerant piping requirements



#### NOTICE

The refrigerant R410A requires strict cautions for keeping the system clean, dry and tight.

- Clean and dry: foreign materials (including mineral oils or moisture) should be prevented from getting mixed into the system.
- Tight: R410A does not contain any chlorine, does not destroy the ozone layer, and does not reduce earth's protection against harmful ultraviolet radiation. R410A can contribute to the greenhouse effect if it is released. Therefore pay special attention to check the tightness of the installation.



#### NOTICE

The piping and other pressure-containing parts shall be suitable for refrigerant. Use phosphoric acid deoxidised seamless copper for refrigerant piping.



#### INFORMATION

Also read the precautions and requirements in the "[1 General safety precautions](#)" [▶ 6].

- Foreign materials inside pipes (including oils for fabrication) must be ≤30 mg/10 m.

### 5.2.2 Refrigerant piping material

- Piping material:** phosphoric acid deoxidised seamless copper
- Piping temper grade and thickness:**

Outer diameter (∅)	Temper grade	Thickness (t) <sup>(a)</sup>	
6.4 mm (1/4") 9.5 mm (3/8") 12.7 mm (1/2")	Annealed (O)	≥0.80 mm	
15.9 mm (5/8")	Annealed (O)	≥0.99 mm	
19.1 mm (3/4") 22.2 mm (7/8")	Half hard (1/2H)	≥0.80 mm	
25.4 mm (1")	Half hard (1/2H)	≥0.88 mm	
28.6 mm (1-1/8")	Half hard (1/2H)	≥0.99 mm	

<sup>(a)</sup> Depending on the applicable legislation and the maximum working pressure of the unit (see "PS High" on the unit name plate), larger piping thickness might be required.

### 5.2.3 To select the piping size

Determine the proper size using the following tables for connections to DX indoor units and AHU units (the reference figure is only for indication).

**i** **INFORMATION**

- Combination of VRV DX and RA DX indoor units is not allowed.
- Combination of RA DX and AHU indoor units is not allowed.
- Combination of RA DX and air curtain indoor units is not allowed.

**i** **INFORMATION**

In case of RXYSQ8: If you install RA DX indoor units, you have to configure field setting [2-41] (= type of installed indoor units). See "7.1.8 Mode 2: field settings" [80].

In case of RXYSQ10+12: The type of indoor units is detected automatically.

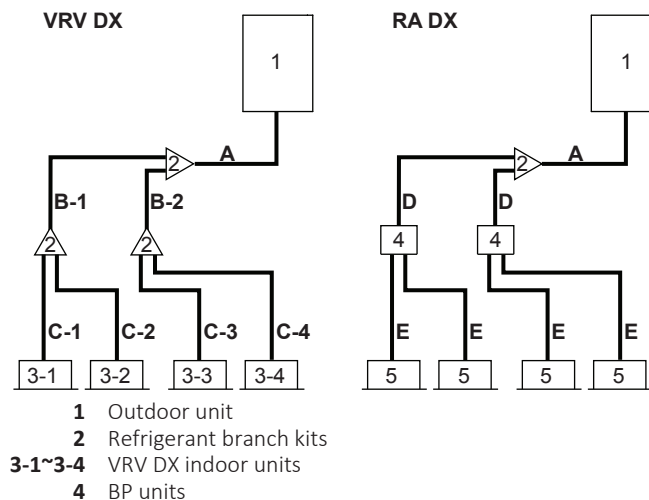



- 5 RA DX indoor units
- A Piping between outdoor unit and (first) refrigerant branch kit
- B-1 B-2 Piping between refrigerant branch kits
- C-1~C-4 Piping between refrigerant branch kit and indoor unit
- D Piping between refrigerant branch kit and BP unit
- E Piping between BP unit and RA DX indoor unit

In case the required pipe sizes (inch sizes) are not available, it is also allowed to use other diameters (mm sizes), taken the following into account:

- Select the pipe size nearest to the required size.
- Use the suitable adapters for the changeover from inch to mm pipes (field supply).
- The additional refrigerant calculation has to be adjusted as mentioned in "6.6.3 To determine the additional refrigerant amount" [▶ 58].

### A: Piping between outdoor unit and (first) refrigerant branch kit

When the equivalent pipe length between outdoor unit and the furthest indoor unit is 90 m or more, the size of the main pipes (both gas side and liquid side) must be increased. Depending on the length of the piping, the capacity may drop, but even in such a case the size of the main pipes has to be increased. More specifications can be found in the technical engineering data book.

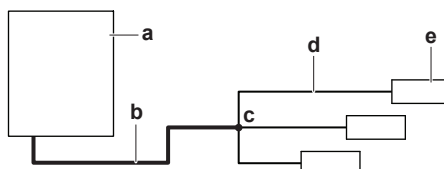

- a Outdoor unit
- b Main gas pipe (increase piping size if length b+d ≥ 90 m)
- c First refrigerant branch kit
- d Piping between indoor unit and first refrigerant branch kit
- e Furthest indoor unit

Outdoor unit capacity type (HP)	Piping outer diameter size (mm)			
	Gas pipe		Liquid pipe	
	Standard	Size-up	Standard	Size-up
8	19.1	22.2	9.5	12.7
10	22.2	25.4 <sup>(a)</sup>		
12	25.4 <sup>(b)</sup>	28.6	12.7	15.9

(a) If size is NOT available, increase is NOT allowed.

(b) If size is NOT available, increase to 28.6 mm is allowed.

### B: Piping between refrigerant branch kits

Choose from the following table in accordance with the indoor unit total capacity type, connected downstream. Do not let the connection piping exceed the refrigerant piping size chosen by the general system model name.

Indoor unit capacity index	Piping outer diameter size (mm)	
	Gas pipe	Liquid pipe
<150	15.9	9.5
150≤x<200	19.1	
200≤x<290	22.2	
290≤x<390	28.6	12.7

**Example:** Downstream capacity for B-1 = capacity index of unit 3-1 + capacity index of unit 3-2

### C: Piping between refrigerant branch kit and indoor unit

Use the same diameters as the connections (liquid, gas) on the indoor units. The diameters of the indoor units are as follows:

Indoor unit capacity index	Piping outer diameter size (mm)	
	Gas pipe	Liquid pipe
15~50	12.7	6.4
63~140	15.9	9.5
200	19.1	
250	22.2	

### D: Piping between refrigerant branch kit and BP unit

Total capacity index of connected indoor units	Piping outer diameter size (mm)	
	Gas pipe	Liquid pipe
15~62	12.7	6.4
63~149	15.9	9.5
150~208	19.1	

### E: Piping between BP unit and RA DX indoor unit

Indoor unit capacity index	Piping outer diameter size (mm)	
	Gas pipe	Liquid pipe
15~42	9.5	6.4
50	12.7	
60		9.5
71	15.9	

## 5.2.4 To select refrigerant branch kits

For piping example, refer to "5.2.3 To select the piping size" [▶ 32].

### Refnet joint at first branch (counting from outdoor unit)

When using refnet joints at the first branch counted from the outdoor unit side, choose from the following table in accordance with the capacity of the outdoor unit. **Example:** Refnet joint A→B-1.

Outdoor unit capacity type (HP)	Refrigerant branch kit
8+10	KHRQ22M29T9
12	KHRQ22M64T

### Refnet joints at other branches

For refnet joints other than the first branch, select the proper branch kit model based on the total capacity index of all indoor units connected after the refrigerant branch. **Example:** Refnet joint B-1→C-1.

Indoor unit capacity index	Refrigerant branch kit
<200	KHRQ22M20TA

Indoor unit capacity index	Refrigerant branch kit
$200 \leq x < 290$	KHRQ22M29T9
$290 \leq x < 390$	KHRQ22M64T

### Refnet headers

Concerning refnet headers, choose from the following table in accordance with the total capacity of all the indoor units connected below the refnet header.

Indoor unit capacity index	Refrigerant branch kit
<200	KHRQ22M29H
$200 \leq x < 290$	
$290 \leq x < 390$	KHRQ22M64H



#### INFORMATION

Maximum 8 branches can be connected to a header.

## 5.2.5 Refrigerant piping length and height difference

### Connection with only VRV DX and RA DX indoor units

The piping lengths and height differences must comply with the following requirements. Two patterns will be discussed:



- Outdoor with 100% VRV DX indoor units
- Outdoor with 100% RA DX indoor units

Requirement	Limit					
	RXYSQ8		RXYSQ10		RXYSQ12	
	VRV DX	RA DX	VRV DX	RA DX	VRV DX	RA DX
<b>Maximum actual piping length</b> <ul style="list-style-type: none"> <li>▪ Example 1.1, unit 8: <math>a+b+c+d+e+f+g+p \leq \text{Limit}</math></li> <li>▪ Example 1.2, unit 6: <math>a+b+h \leq \text{Limit}</math></li> <li>▪ Example 1.2, unit 8: <math>a+i+k \leq \text{Limit}</math></li> <li>▪ Example 1.3, unit 8: <math>a+i \leq \text{Limit}</math></li> <li>▪ Example 2, unit 18: <math>a+b+m \leq \text{Limit}</math></li> </ul>	100 m	70 m	120 m	70 m	120 m	70 m
<b>Maximum equivalent piping length<sup>(a)</sup></b>	130 m	90 m	150 m	90 m	150 m	90 m
<b>Maximum total piping length</b> <ul style="list-style-type: none"> <li>▪ Example 1.1: <math>a+b+c+d+e+f+g+h+i+j+k+l+m+n+p \leq \text{Limit}</math></li> <li>▪ Example 2: <math>a+b+c+d+e+f+g+h+i+j+k+l+m \leq \text{Limit}</math></li> </ul>	300	140 m	300 m	140 m	300 m	140 m
<b>Minimum length outdoor-first refrigerant branch kit</b> <ul style="list-style-type: none"> <li>▪ Example 2: <math>\text{Limit} \leq a</math></li> </ul>	N/A	5 m	N/A	5 m	N/A	5 m
<b>Maximum length first branch kit-indoor unit</b> <ul style="list-style-type: none"> <li>▪ Example 1.1, unit 8: <math>b+c+d+e+f+g+p \leq \text{Limit}</math></li> <li>▪ Example 1.2, unit 6: <math>b+h \leq \text{Limit}</math></li> <li>▪ Example 1.2, unit 8: <math>i+k \leq \text{Limit}</math></li> <li>▪ Example 1.3, unit 8: <math>i \leq \text{Limit}</math></li> <li>▪ Example 2, unit 18: <math>b+m \leq \text{Limit}</math></li> </ul>	40 m	40 m	40 m	40 m	40 m	40 m

Requirement	Limit						
	RXYSQ8		RXYSQ10		RXYSQ12		
	VRV DX	RA DX	VRV DX	RA DX	VRV DX	RA DX	
<b>Maximum length outdoor-BP</b> ■ Example 2, BP3: $a+b \leq \text{Limit}$	N/A	55 m	N/A	55 m	N/A	55 m	
<b>Minimum and maximum length BP-indoor</b> ■ Example 2, unit 18: $\text{Min.} \leq m \leq \text{Max.}$	Indoor unit capacity index < 60	N/A	2~15 m	N/A	2~15 m	N/A	2~15 m
	Indoor unit capacity index = 60	N/A	2~12 m	N/A	2~12 m	N/A	2~12 m
	Indoor unit capacity index = 71	N/A	2~8 m	N/A	2~8 m	N/A	2~8 m
<b>Maximum height difference outdoor-indoor</b> ■ Examples: $H1 \leq \text{Limit}$	Outdoor higher than indoor	50 m	30 m	50 m	30 m	50 m	30 m
	Outdoor lower than indoor	40 m		40 m		40 m	
<b>Maximum height difference indoor-indoor</b> ■ Examples: $H2 \leq \text{Limit}$	15 m	15 m	15 m	15 m	15 m	15 m	
<b>Maximum height difference outdoor-BP</b> ■ Example 2: $H3 \leq \text{Limit}$	N/A	30 m	N/A	30 m	N/A	30 m	
<b>Maximum height difference BP-BP</b> ■ Example 2: $H4 \leq \text{Limit}$	N/A	15 m	N/A	15 m	N/A	15 m	
<b>Maximum height difference BP-indoor</b> ■ Example 2: $H5 \leq \text{Limit}$	N/A	5 m	N/A	5 m	N/A	5 m	

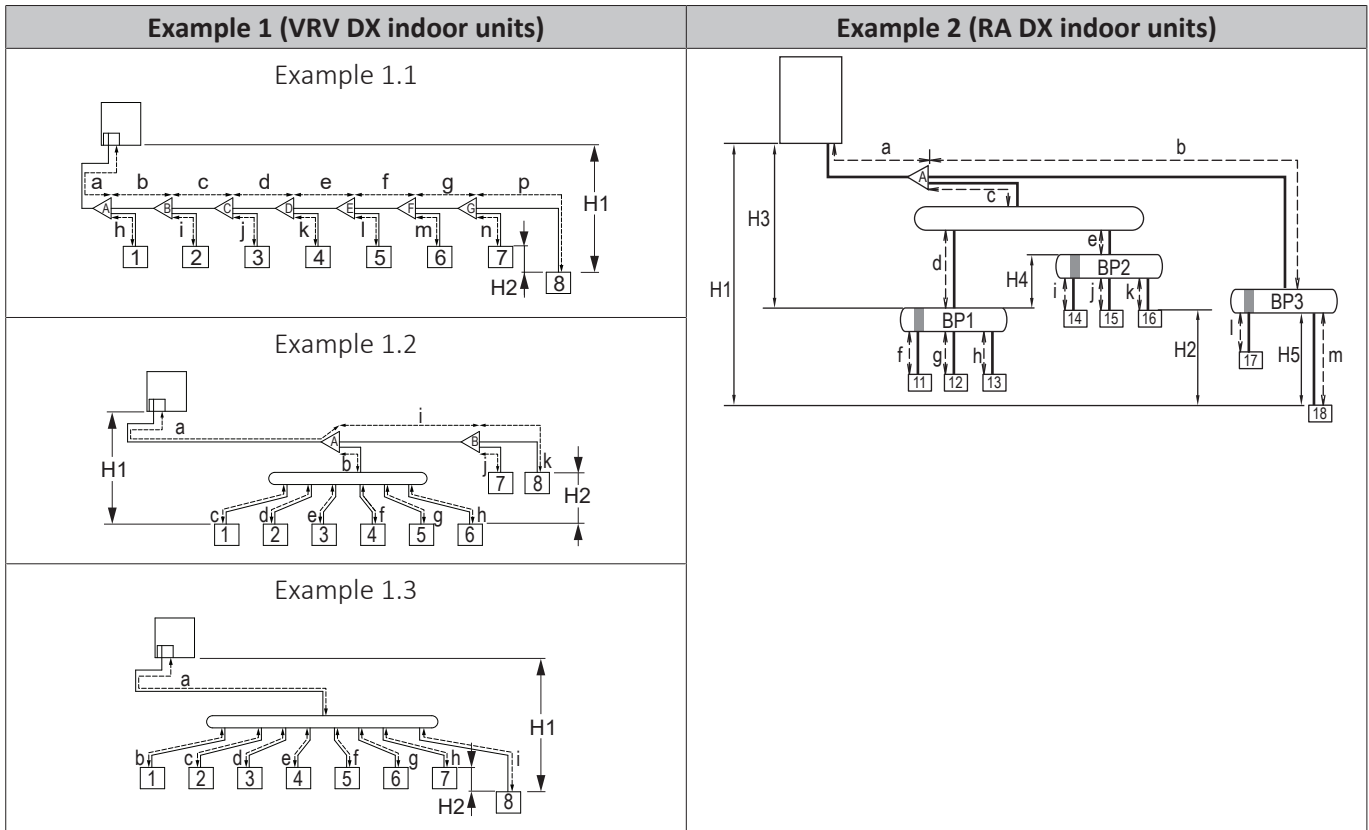
<sup>(a)</sup> Assume equivalent piping length of refnet joint=0.5 m and refnet header=1 m (for calculation purposes of equivalent piping length, not for refrigerant charge calculations).

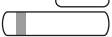

-  Refnet joint  
 Refnet header  
 BP box  
**1~8** VRV DX indoor units  
**11~18** RA DX indoor units

### Connection with only one air handling unit (pair layout)

Pipe	Maximum length (actual/equivalent)
Longest pipe from the outdoor unit	50 m/55 m <sup>(a)</sup>
Total pipe length	150 m/— <sup>(b)</sup>

<sup>(a)</sup> The allowable minimum length is 5 m.

<sup>(b)</sup> Up to three piping branches are possible in case of an AHU with an interlaced heat exchanger.

### Connection with VRV DX indoor units and air handling units (mix layout) and connection with only air handling units (multi layout)



#### INFORMATION

The following figure is an example and may NOT completely match your system layout.

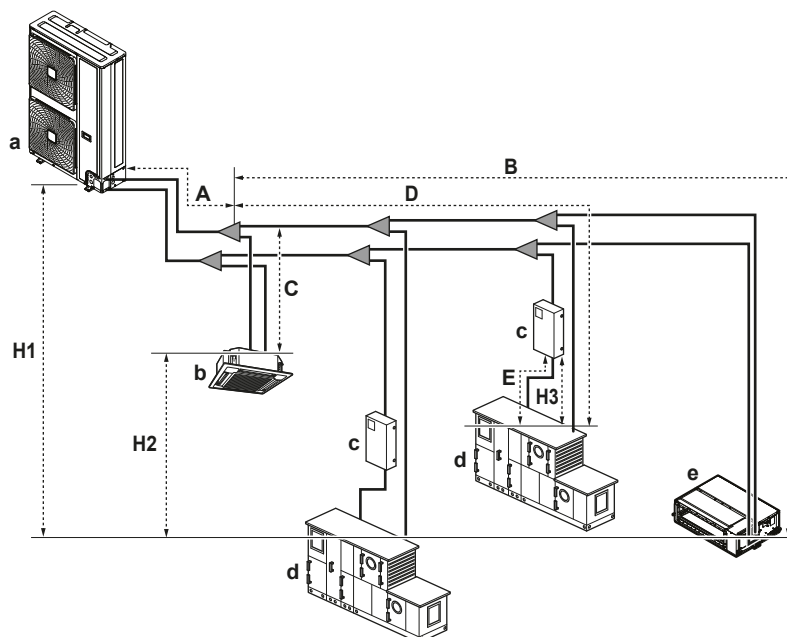

- a Outdoor unit
- b VRV DX indoor unit
- c EKEXV(A)-kit
- d Air handling unit (AHU)
- e VRV DX indoor unit (duct)

Pipe	Maximum length (actual/equivalent)
Longest pipe from the outdoor unit or the last multi-outdoor piping branch (A + [B, D])	50 m/55 m <sup>(a)</sup>
Longest pipe after the first branch (B, D)	40 m/—
Total pipe length	300 m/—

<sup>(a)</sup> The allowable minimum length is 5 m.

**Allowable height difference**

Term	Definition	Height difference [m]
H1	Height difference between outdoor and indoor units	50/55
H2	Height difference between indoor units	15
H3	Height difference between EKEXV(A)-kits and AHU units	5

## 5.3 Preparing electrical wiring

### 5.3.1 About electrical compliance

This equipment complies with:

- **EN/IEC 61000-3-12** provided that the short-circuit power  $S_{sc}$  is greater than or equal to the minimum  $S_{sc}$  value at the interface point between the user's supply and the public system.
  - EN/IEC 61000-3-12 = European/International Technical Standard setting the limits for harmonic currents produced by equipment connected to public low-voltage systems with input current  $>16$  A and  $\leq 75$  A per phase.
  - It is the responsibility of the installer or user of the equipment to ensure, by consultation with the distribution network operator if necessary, that the equipment is connected ONLY to a supply with a short-circuit power  $S_{sc}$  greater than or equal to the minimum  $S_{sc}$  value.

Model	Minimum $S_{sc}$ value
RXYSQ8	910 kVA
RXYSQ10	564 kVA
RXYSQ12	615 kVA

### 5.3.2 Safety device requirements

#### Power supply wiring

The power supply must be protected with the required safety devices, i.e. a main switch, a slow blow fuse on each phase and an earth leakage protector in accordance with the applicable legislation.

Selection and sizing of the wiring should be done in accordance with the applicable legislation based on the information mentioned in the table below.

Model	Minimum circuit ampacity	Recommended fuses
RXYSQ8	18.5 A	25 A
RXYSQ10	22 A	25 A
RXYSQ12	24 A	32 A

For all models:

- Phase and frequency: 3N~ 50 Hz
- Voltage: 380-415 V
- Transmission line section:

Transmission wiring	Vinyl cords with 0.75 to 1.25 mm <sup>2</sup> sheath or cables (2-core wires)
Maximum wiring length (= distance between outdoor and furthest indoor unit)	300 m
Total wiring length (= distance between outdoor and all indoors)	600 m

If the total transmission wiring exceeds these limits, it may result in communication error.

# 6 Installation

## In this chapter

6.1	Overview: Installation.....	40
6.2	Opening the units.....	41
6.2.1	About opening the units.....	41
6.2.2	To open the outdoor unit.....	41
6.3	Mounting the outdoor unit.....	42
6.3.1	About mounting the outdoor unit.....	42
6.3.2	Precautions when mounting the outdoor unit.....	42
6.3.3	To provide the installation structure.....	42
6.3.4	To install the outdoor unit.....	43
6.3.5	To provide drainage.....	43
6.3.6	To prevent the outdoor unit from falling over.....	44
6.4	Connecting the refrigerant piping.....	44
6.4.1	About connecting the refrigerant piping.....	44
6.4.2	Precautions when connecting the refrigerant piping.....	45
6.4.3	Pipe bending guidelines.....	45
6.4.4	To braze the pipe end.....	45
6.4.5	Using the stop valve and service port.....	46
6.4.6	To remove the pinched pipes.....	48
6.4.7	To connect the refrigerant piping to the outdoor unit.....	49
6.4.8	To connect the refrigerant branching kit.....	52
6.5	Checking the refrigerant piping.....	53
6.5.1	About checking the refrigerant piping.....	53
6.5.2	Checking refrigerant piping: General guidelines.....	54
6.5.3	Checking refrigerant piping: Setup.....	54
6.5.4	To perform a leak test.....	55
6.5.5	To perform vacuum drying.....	56
6.5.6	To insulate the refrigerant piping.....	56
6.6	Charging refrigerant.....	57
6.6.1	About charging refrigerant.....	57
6.6.2	Precautions when charging refrigerant.....	57
6.6.3	To determine the additional refrigerant amount.....	58
6.6.4	To charge refrigerant.....	59
6.6.5	Error codes when charging refrigerant.....	61
6.6.6	To fix the fluorinated greenhouse gases label.....	61
6.7	Connecting the electrical wiring.....	62
6.7.1	About connecting the electrical wiring.....	62
6.7.2	To connect the electrical wiring to the outdoor unit.....	67
6.8	Finishing the outdoor unit installation.....	70
6.8.1	To finish the interconnection wiring.....	70
6.8.2	To close the outdoor unit.....	70

## 6.1 Overview: Installation

This chapter describes what you have to do and know on-site to install the system.

### Typical workflow

Installation typically consists of the following stages:

- Mounting the outdoor unit.
- Mounting the indoor units.
- Connecting the refrigerant piping.
- Checking the refrigerant piping.
- Charging refrigerant.
- Connecting the electrical wiring.
- Finishing the outdoor installation.



- Finishing the indoor installation.



#### INFORMATION

For installation of the indoor unit (mounting the indoor unit, connecting the refrigerant piping to the indoor unit, connecting the electrical wiring to the indoor unit ...), see the installation manual of the indoor unit.

## 6.2 Opening the units

### 6.2.1 About opening the units

At certain times, you have to open the unit. **Example:**

- When connecting the refrigerant piping
- When connecting the electrical wiring
- When maintaining or servicing the unit



#### DANGER: RISK OF ELECTROCUTION

Do NOT leave the unit unattended when the service cover is removed.

### 6.2.2 To open the outdoor unit



#### DANGER: RISK OF ELECTROCUTION



#### DANGER: RISK OF BURNING/SCALDING

8 HP

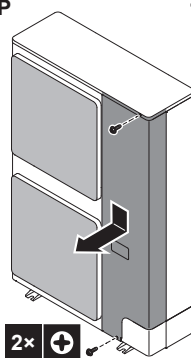

10+12 HP

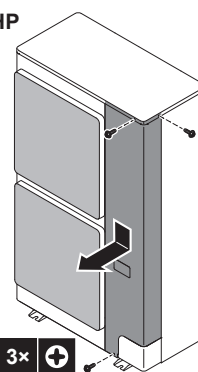

## 6.3 Mounting the outdoor unit

### 6.3.1 About mounting the outdoor unit

#### Typical workflow

Mounting the outdoor unit typically consists of the following stages:

- 1 Providing the installation structure.
- 2 Installing the outdoor unit.
- 3 Providing drainage.
- 4 Preventing the unit from falling over.

### 6.3.2 Precautions when mounting the outdoor unit



#### INFORMATION

Also read the precautions and requirements in the following chapters:

- General safety precautions
- Preparation

### 6.3.3 To provide the installation structure

Check the strength and level of the installation ground so that the unit will not cause any operating vibration or noise.

Fix the unit securely by means of foundation bolts in accordance with the foundation drawing.

Prepare four sets of anchor bolts, nuts, and washers (field supply) as follows:

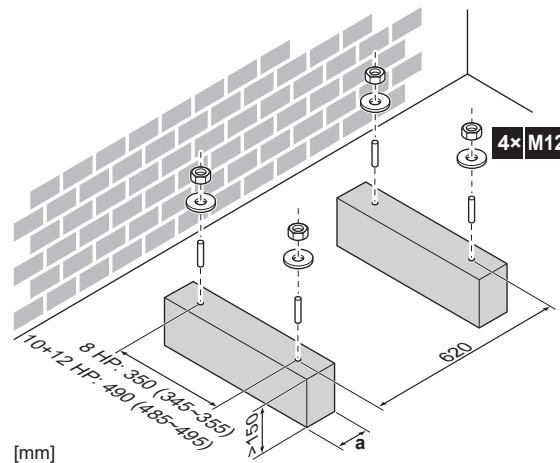

- a** Make sure not to cover the drain holes of the bottom plate of the unit.

6.3.4 To install the outdoor unit

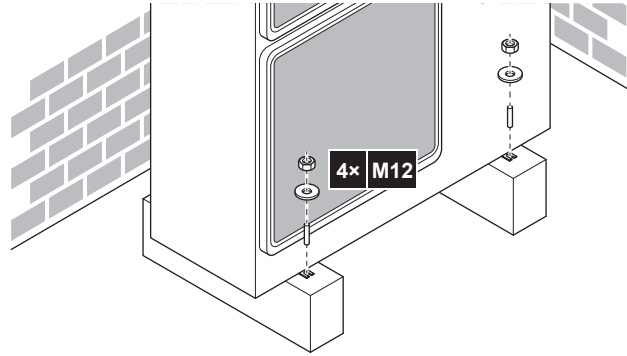

6.3.5 To provide drainage

- Make sure that condensation water can be evacuated properly.
- Install the unit on a base to make sure that there is proper drainage in order to avoid ice accumulation.
- Prepare a water drainage channel around the foundation to drain waste water away from the unit.
- Avoid drain water flowing over the footpath, so that it does NOT become slippery in case of ambient freezing temperatures.
- If you install the unit on a frame, install a waterproof plate within 150 mm of the bottom side of the unit in order to prevent water from getting into the unit and to avoid drain water dripping (see the following figure).



**NOTICE**

If drain holes of the outdoor unit are covered by a mounting base or by floor surface, raise the unit to provide a free space of more than 150 mm under the outdoor unit.

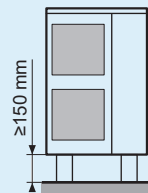

**Drain holes (dimensions in mm)**

Model	Bottom view (mm)
RXYSQ8	

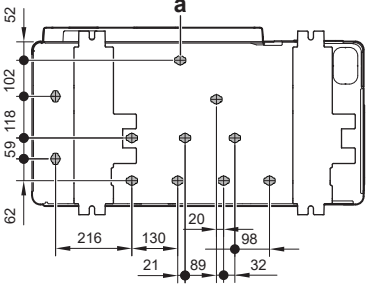
Model	Bottom view (mm)
RXYSQ10+12	

a Drain holes

### 6.3.6 To prevent the outdoor unit from falling over

In case the unit is installed in places where strong wind can tilt the unit, take following measure:

- 1 Prepare 2 cables as indicated in the following illustration (field supply).
- 2 Place the 2 cables over the outdoor unit.
- 3 Insert a rubber sheet between the cables and the outdoor unit to prevent the cables from scratching the paint (field supply).
- 4 Attach the ends of the cables.
- 5 Tighten the cables.

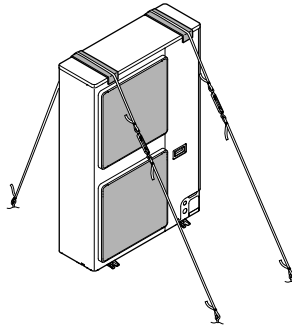

## 6.4 Connecting the refrigerant piping

### 6.4.1 About connecting the refrigerant piping

#### Before connecting the refrigerant piping

Make sure the outdoor and indoor units are mounted.

#### Typical workflow

Connecting the refrigerant piping involves:

- Connecting the refrigerant piping to the outdoor unit
- Connecting refrigerant branch kits
- Connecting the refrigerant piping to the indoor units (see the installation manual of the indoor units)
- Insulating the refrigerant piping

- Keeping in mind the guidelines for:
  - Pipe bending
  - Brazing
  - Using the stop valves
  - Removing pinched pipes

#### 6.4.2 Precautions when connecting the refrigerant piping



#### **DANGER: RISK OF BURNING/SCALDING**



#### **NOTICE**

Take the following precautions on refrigerant piping into account:

- Avoid anything but the designated refrigerant to get mixed into the refrigerant cycle (e.g. air).
- Only use R410A when adding refrigerant.
- Only use installation tools (e.g. manifold gauge set) that are exclusively used for R410A installations to withstand the pressure and to prevent foreign materials (e.g. mineral oils and moisture) from mixing into the system.
- Protect the piping as described in the following table to prevent dirt, liquid or dust from entering the piping.
- Use caution when passing copper tubes through walls.

Unit	Installation period	Protection method
Outdoor unit	>1 month	Pinch the pipe
	<1 month	Pinch or tape the pipe
Indoor unit	Regardless of the period	



#### **NOTICE**

Do NOT open the refrigerant stop valve before checking the refrigerant piping. When you need to charge additional refrigerant it is recommended to open the refrigerant stop valve after charging.

#### 6.4.3 Pipe bending guidelines

Use a pipe bender for bending. All pipe bends should be as gentle as possible (bending radius should be 30~40 mm or larger).

#### 6.4.4 To braze the pipe end



#### **DANGER: RISK OF BURNING/SCALDING**

**NOTICE**

Precautions when connecting field piping. Add brazing material as shown in the figure.

- When brazing, blow through with nitrogen to prevent creation of large quantities of oxidised film on the inside of the piping. This film adversely affects valves and compressors in the refrigerating system and prevents proper operation.
- Set the nitrogen pressure to 20 kPa (0.2 bar) (just enough so it can be felt on the skin) with a pressure-reducing valve.

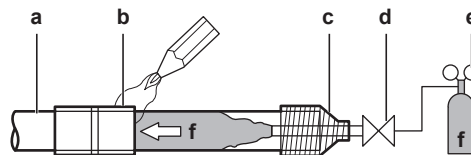

- a Refrigerant piping
- b Part to be brazed
- c Taping
- d Manual valve
- e Pressure-reducing valve
- f Nitrogen

- Do NOT use anti-oxidants when brazing pipe joints. Residue can clog pipes and break equipment.
- Do NOT use flux when brazing copper-to-copper refrigerant piping. Use phosphor copper brazing filler alloy (BCuP), which does NOT require flux.

Flux has an extremely harmful influence on refrigerant piping systems. For instance, if chlorine based flux is used, it will cause pipe corrosion or, in particular, if the flux contains fluorine, it will deteriorate the refrigerant oil.

- ALWAYS protect the surrounding surfaces (e.g. insulation foam) from heat when brazing.

### 6.4.5 Using the stop valve and service port

#### To handle the stop valve

Take the following guidelines into account:

- The gas and liquid stop valves are factory closed.
- Make sure to keep all stop valves open during operation.
- The figures below show the name of each part required in handling the stop valve.

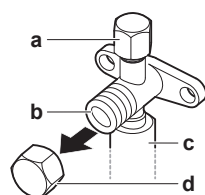

- a Service port and service port cover
- b Stop valve

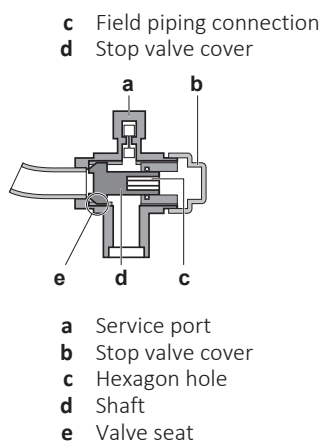

- Do NOT apply excessive force to the stop valve. Doing so may break the valve body.

### To open the stop valve

- Remove the stop valve cover.
- Insert a hexagon wrench into the stop valve and turn the stop valve counterclockwise.

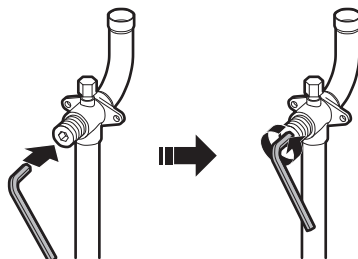

- When the stop valve cannot be turned any further, stop turning.
- Install the stop valve cover.

**Result:** The valve is now open.

To fully open the  $\varnothing 19.1 \sim \varnothing 25.4$  mm stop valve, turn the hexagonal wrench until a torque between 27 and 33 N•m is achieved.

Inadequate torque may cause leakage of refrigerant and breakage of the stop valve cap.



#### NOTICE

Pay attention that mentioned torque range is applicable for opening  $\varnothing 19.1 \sim \varnothing 25.4$  mm stop valves only.

### To close the stop valve

- Remove the stop valve cover.
- Insert a hexagon wrench into the stop valve and turn the stop valve clockwise.

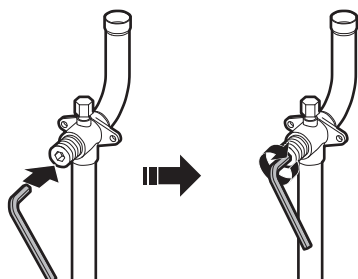

- 3 When the stop valve cannot be turned any further, stop turning.
- 4 Install the stop valve cover.

**Result:** The valve is now closed.

**To handle the stop valve cover**

- The stop valve cover is sealed where indicated by the arrow. Do NOT damage it.
- After handling the stop valve, tighten the stop valve cover securely, and check for refrigerant leaks. For the tightening torque, refer to the table below.

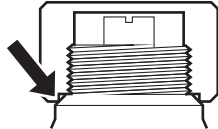

**To handle the service port**

- Always use a charge hose equipped with a valve depressor pin, since the service port is a Schrader type valve.
- After handling the service port, make sure to tighten the service port cover securely. For the tightening torque, refer to the table below.
- Check for refrigerant leaks after tightening the service port cover.

**Tightening torques**

Stop valve size (mm)	Tightening torque N•m (turn clockwise to close)			
	Shaft			
	Valve body	Hexagonal wrench	Cap (valve lid)	Service port
∅9.5	5.4~6.6	4 mm	13.5~16.5	11.5~13.9
∅12.7	8.1~9.9		18.0~22.0	
∅19.1	27.0~33.0	8 mm	22.5~27.5	
∅25.4				

6.4.6 To remove the pinched pipes



**WARNING**

Any gas or oil remaining inside the stop valve may blow off the pinched piping. Failure to observe the instructions in procedure below properly may result in property damage or personal injury, which may be serious depending on the circumstances.

Use the following procedure to remove the pinched piping:

- 1 Make sure that the stop valves are fully closed.



- 2 Connect the vacuuming/recovery unit through a manifold to the service port of all stop valves.



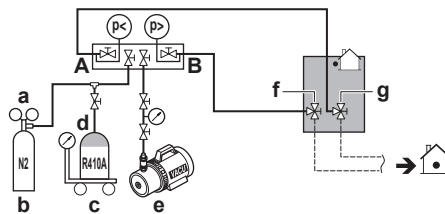

- a Pressure reducing valve
- b Nitrogen
- c Weighing scales
- d Refrigerant R410A tank (siphon system)
- e Vacuum pump
- f Liquid line stop valve
- g Gas line stop valve
- A Valve A
- B Valve B

- 3 Recover gas and oil from the pinched piping by using a recovery unit.

**CAUTION**

Do NOT vent gases into the atmosphere.

- 4 When all gas and oil is recovered from the pinched piping, disconnect the charge hose and close the service ports.
- 5 Cut off the lower part of the gas and liquid stop valve pipes along the black line. Use an appropriate tool (e.g. a pipe cutter).

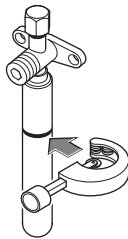
**WARNING**

NEVER remove the pinched piping by brazing.

Any gas or oil remaining inside the stop valve may blow off the pinched piping.

- 6 Wait until all oil has dripped out before continuing with the connection of the field piping in case the recovery was not complete.

#### 6.4.7 To connect the refrigerant piping to the outdoor unit

**NOTICE**

Be sure that the field installed piping does not touch other pipes, the bottom panel or side panel. Especially for the bottom and side connection, be sure to protect the piping with suitable insulation, to prevent it from coming into contact with the casing.

- 1 Do the following:
  - Remove the service cover. See "6.2.2 To open the outdoor unit" [▶ 41].
  - Remove the piping intake plate (a) with screw (b).

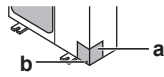

2 Choose a piping route (a, b, c or d).

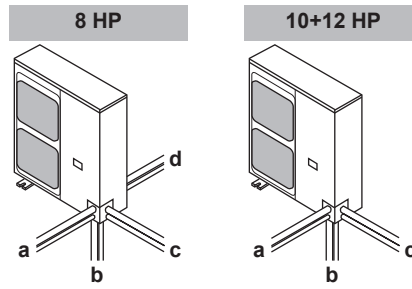

**INFORMATION**

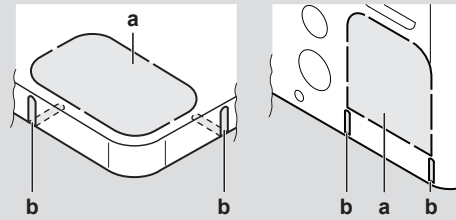

- Punch out the knockout (a) in the bottom plate or cover plate by tapping on the attachment points with a flat head screwdriver and a hammer.
- Optionally, cut out the slits (b) with a metal saw.



**NOTICE**

Precautions when making knockout holes:

- Avoid damaging the casing and underlying piping.
- After making the knockout holes, we recommend to remove the burrs and paint the edges and areas around the edges using repair paint to prevent rusting.
- When passing electrical wiring through the knockout holes, wrap the wiring with protective tape to prevent damage.

3 Do the following:

- Connect the liquid pipe (a) to the liquid stop valve. (brazing)
- Connect the gas pipe (b) to the gas stop valve. (brazing)

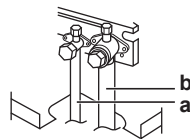

**NOTICE**

**When brazing:** First braise the liquid side piping, then the gas side piping. Enter the electrode from the front of the unit and the welding torch from the right side to braise with the flames facing outside and avoid the compressor sound insulation and other piping.

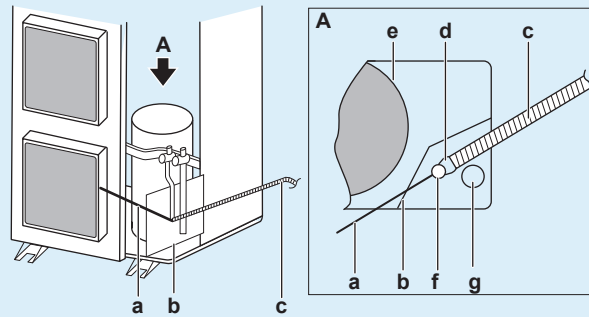

- a** Electrode
- b** Burning-resistant plate
- c** Welding torch
- d** Flames
- e** Compressor sound insulation
- f** Liquid side piping
- g** Gas side piping

- Connect the gas piping accessories (c, d), and cut them to the required length (d1).

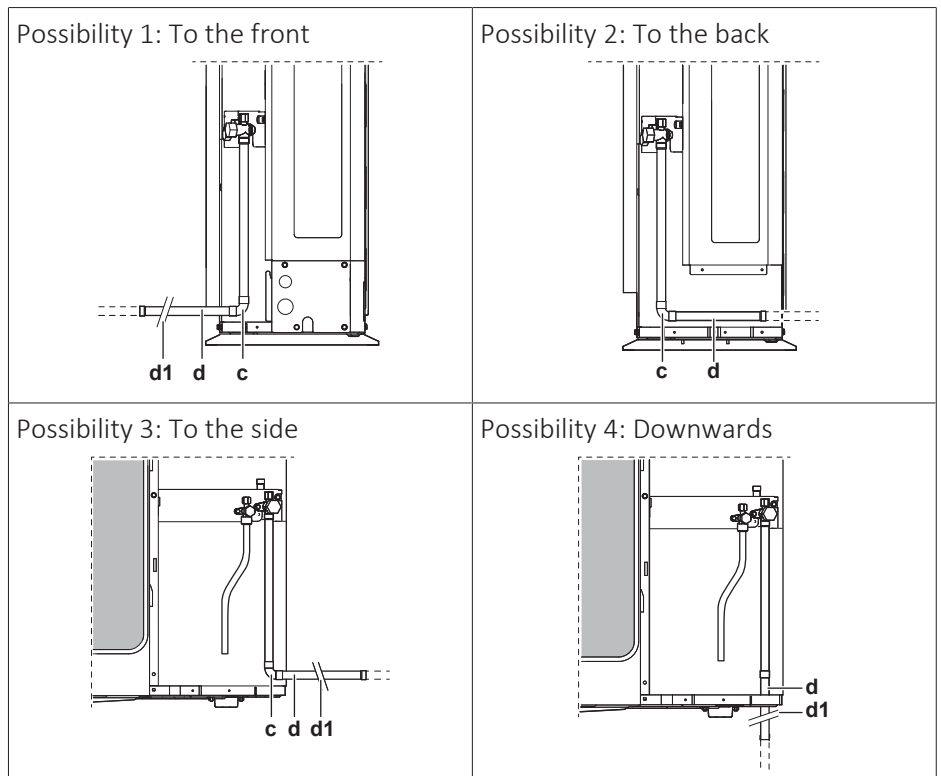

- 4** Reattach the service cover and the piping intake plate.
- 5** Seal all gaps (example: a) to prevent snow and small animals from entering the system.

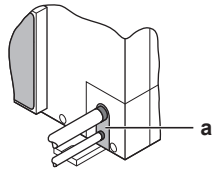

**WARNING**

Provide adequate measures to prevent that the unit can be used as a shelter by small animals. Small animals that make contact with electrical parts can cause malfunctions, smoke or fire.



**NOTICE**

Make sure to open the stop valves after installing the refrigerant piping and performing vacuum drying. Running the system with the stop valves closed may break the compressor.

6.4.8 To connect the refrigerant branching kit

For installation of the refrigerant branching kit, refer to the installation manual delivered with the kit.

- Mount the refnet joint so that it branches either horizontally or vertically.
- Mount the refnet header so that it branches horizontally.

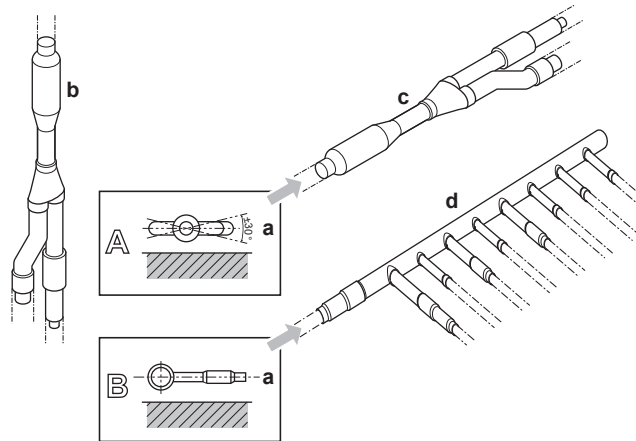

- a Horizontal surface
- b Refnet joint mounted vertically
- c Refnet joint mounted horizontally
- d Header

## 6.5 Checking the refrigerant piping

### 6.5.1 About checking the refrigerant piping

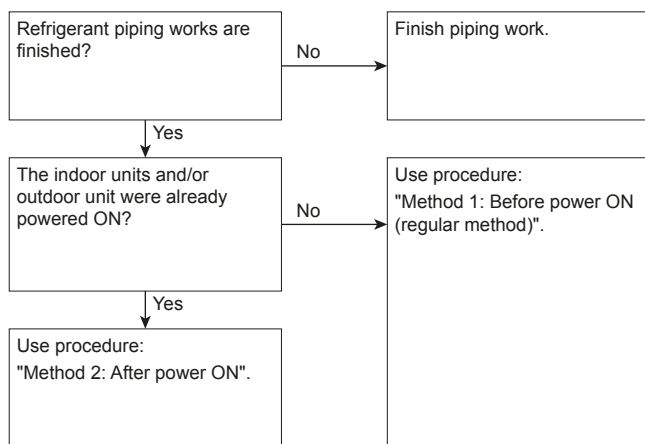

It is very important that all refrigerant piping work is done before the units (outdoor or indoor) are powered on. When the units are powered on, the expansion valves will initialise. This means that the valves will close.



#### NOTICE

Leak test and vacuum drying of field piping and indoor units is impossible when field expansion valves are closed.

#### Method 1: Before power ON

If the system has not yet been powered on, no special action is required to perform the leak test and the vacuum drying.

#### Method 2: After power ON

If the system has already been powered on, activate setting [2-21] (refer to "7.1.4 To access mode 1 or 2" [▶ 74]). This setting will open field expansion valves to guarantee a refrigerant piping pathway and make it possible to perform the leak test and the vacuum drying.



#### DANGER: RISK OF ELECTROCUTION



#### NOTICE

Make sure that all indoor units connected to the outdoor unit are powered on.



#### NOTICE

Wait to apply setting [2-21] until the outdoor unit has finished the initialisation.

#### Leak test and vacuum drying

Checking the refrigerant piping involves:

- Checking for any leakages in the refrigerant piping.
- Performing vacuum drying to remove all moisture, air or nitrogen in the refrigerant piping.

If there is a possibility of moisture being present in the refrigerant piping (for example, water may have entered the piping), first carry out the vacuum drying procedure below until all moisture has been removed.

All piping inside the unit has been factory tested for leaks.

Only field installed refrigerant piping needs to be checked. Therefore, make sure that all the outdoor unit stop valves are firmly closed before performing leak test or vacuum drying.

**NOTICE**  
 Make sure that all (field supplied) field piping valves are OPEN (not outdoor unit stop valves!) before you start leak test and vacuuming.

For more information on the state of the valves, refer to "6.5.3 Checking refrigerant piping: Setup" [▶ 54].

### 6.5.2 Checking refrigerant piping: General guidelines

Connect the vacuum pump through a manifold to the service port of all stop valves to increase efficiency (refer to "6.5.3 Checking refrigerant piping: Setup" [▶ 54]).

**NOTICE**  
 Use a 2-stage vacuum pump with a non-return valve or a solenoid valve that can evacuate to a gauge pressure of  $-100.7 \text{ kPa}$  ( $-1.007 \text{ bar}$ ).

**NOTICE**  
 Make sure the pump oil does not flow oppositely into the system while the pump is not working.

**NOTICE**  
 Do NOT purge the air with refrigerants. Use a vacuum pump to evacuate the installation.

### 6.5.3 Checking refrigerant piping: Setup

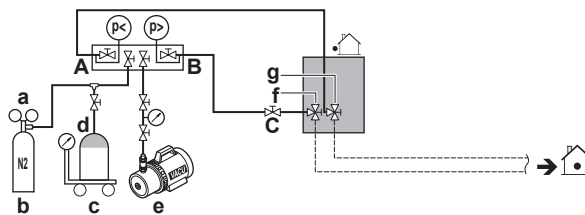

- a Pressure reducing valve
- b Nitrogen
- c Weighing scales
- d Refrigerant R410A tank (siphon system)
- e Vacuum pump
- f Liquid line stop valve
- g Gas line stop valve
- A Valve A
- B Valve B
- C Valve C

Valve	Status
Valve A	Open
Valve B	Open

Valve	Status
Valve C	Open
Liquid line stop valve	Close
Gas line stop valve	Close

**NOTICE**

The connections to the indoor units and all indoor units should also be leak and vacuum tested. Keep any possible (field supplied) field piping valves open as well.

Refer to the indoor unit installation manual for more details. Leak test and vacuum drying should be done before the power supply is set to the unit. If not, see also the flow chart earlier described in this chapter (see "[6.5.1 About checking the refrigerant piping](#)" [▶ 53]).

## 6.5.4 To perform a leak test

The leak test must satisfy the specifications of EN378-2.

**Vacuum leak test**

- 1 Evacuate the system from the liquid and gas piping to a gauge pressure of  $-100.7$  kPa ( $-1.007$  bar) for more than 2 hours.
- 2 Once reached, turn off the vacuum pump and check that the pressure does not rise for at least 1 minute.
- 3 Should the pressure rise, the system may either contain moisture (see vacuum drying below) or have leaks.

**Pressure leak test**

- 1 Break the vacuum by pressurising with nitrogen gas to a minimum gauge pressure of  $0.2$  MPa (2 bar). Never set the gauge pressure higher than the maximum operation pressure of the unit, i.e.  $4.0$  MPa (40 bar).
- 2 Test for leaks by applying a bubble test solution to all piping connections.
- 3 Discharge all nitrogen gas.

**NOTICE**

ALWAYS use a recommended bubble test solution from your wholesaler.

NEVER use soap water:

- Soap water may cause cracking of components, such as flare nuts or stop valve caps.
- Soap water may contain salt, which absorbs moisture that will freeze when the piping gets cold.
- Soap water contains ammonia which may lead to corrosion of flared joints (between the brass flare nut and the copper flare).

6.5.5 To perform vacuum drying



**NOTICE**

The connections to the indoor units and all indoor units should also be leak and vacuum tested. Keep, if existing, all (field supplied) field valves to the indoor units open as well.

Leak test and vacuum drying should be done before the power supply is set to the unit. If not, see "6.5.1 About checking the refrigerant piping" [▶ 53] for more information.

To remove all moisture from the system, proceed as follows:

- 1 Evacuate the system for at least 2 hours to a target vacuum of  $-100.7 \text{ kPa}$  ( $-1.007 \text{ bar}$ )( $5 \text{ Torr absolute}$ ).
- 2 Check that, with the vacuum pump turned off, the target vacuum is maintained for at least 1 hour.
- 3 Should you fail to reach the target vacuum within 2 hours or maintain the vacuum for 1 hour, the system may contain too much moisture. In that case, break the vacuum by pressurising with nitrogen gas to a gauge pressure of  $0.05 \text{ MPa}$  ( $0.5 \text{ bar}$ ) and repeat steps 1 to 3 until all moisture has been removed.
- 4 Depending on whether you want to immediately charge refrigerant through the refrigerant charge port or first pre-charge a portion of refrigerant through the liquid line, either open the outdoor unit stop valves, or keep them closed. See "6.6.4 To charge refrigerant" [▶ 59] for more information.



**INFORMATION**

After opening the stop valve, it is possible that the pressure in the refrigerant piping does NOT increase. This might be caused by e.g. the closed state of the expansion valve in the outdoor unit circuit, but does NOT present any problem for correct operation of the unit.

6.5.6 To insulate the refrigerant piping

After finishing the leak test and vacuum drying, the piping must be insulated. Take into account the following points:

- Make sure to insulate the connection piping and refrigerant branch kits entirely.
- Be sure to insulate the liquid and gas piping (for all units).
- Use heat resistant polyethylene foam which can withstand a temperature of  $70^\circ\text{C}$  for liquid piping and polyethylene foam which can withstand a temperature of  $120^\circ\text{C}$  for gas piping.
- Reinforce the insulation on the refrigerant piping according to the installation environment.

Ambient temperature	Humidity	Minimum thickness
$\leq 30^\circ\text{C}$	75% to 80% RH	15 mm
$> 30^\circ\text{C}$	$\geq 80\%$ RH	20 mm

- If there is a possibility that condensation on the stop valve might drip down into the indoor unit through gaps in the insulation and piping because the outdoor unit is located higher than the indoor unit, this must be prevented by sealing up the connections. See below figure.



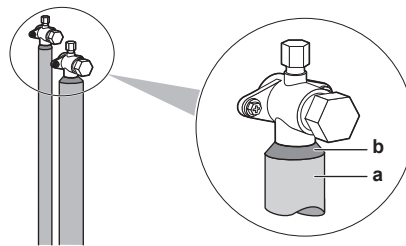

- a** Insulation material  
**b** Caulking etc.

## 6.6 Charging refrigerant

### 6.6.1 About charging refrigerant

The outdoor unit is factory charged with refrigerant, but depending on the field piping you have to charge additional refrigerant.

#### Before charging refrigerant

Make sure the outdoor unit's **external** refrigerant piping is checked (leak test, vacuum drying).

#### Typical workflow

Charging additional refrigerant typically consists of the following stages:

- 1 Determining how much you have to charge additionally.
- 2 Charging additional refrigerant (pre-charging and/or charging).
- 3 Filling in the fluorinated greenhouse gases label, and fixing it to the inside of the outdoor unit.

### 6.6.2 Precautions when charging refrigerant



#### INFORMATION

Also read the precautions and requirements in the following chapters:

- General safety precautions
- Preparation



#### WARNING

- ONLY use R410A as refrigerant. Other substances may cause explosions and accidents.
- R410A contains fluorinated greenhouse gases. Its global warming potential (GWP) value is 2087.5. Do NOT vent these gases into the atmosphere.
- When charging refrigerant, ALWAYS use protective gloves and safety glasses.



#### NOTICE

If the power of some units is turned off, the charging procedure cannot be finished properly.



#### NOTICE

Turn ON the power 6 hours before operation in order to have power running to the crankcase heater and to protect the compressor.



**NOTICE**

If operation is performed within 12 minutes after the indoor and outdoor units are powered on, the compressor will not operate before the communication is established in a correct way between outdoor unit(s) and indoor units.



**NOTICE**

Before starting charging procedures:

- In case of RXYSQ8: Check if the 7-LEDs display is as normal (see "7.1.4 To access mode 1 or 2" [▶ 74]), and there is no malfunction code on the user interface of the indoor unit. If a malfunction code is present, see "11.3 Solving problems based on error codes" [▶ 101].
- In case of RXYSQ10+12: Check if the 7-segment display indication of the outdoor unit A1P PCB is as normal (see "7.1.4 To access mode 1 or 2" [▶ 74]). If a malfunction code is present, see "11.3 Solving problems based on error codes" [▶ 101].



**NOTICE**

Make sure all connected indoor units are recognised (in case of RXYSQ8: setting [1-5]; in case of RXYSQ10+12: setting [1-10]).



**NOTICE**

Close the front panel before any refrigerant charge operation is executed. Without the front panel attached the unit cannot judge correctly whether it is operating properly or not.



**NOTICE**

In case of maintenance and the system (outdoor unit+field piping+indoor units) does not contain any refrigerant any more (e.g., after refrigerant reclaim operation), the unit has to be charged with its original amount of refrigerant (refer to the nameplate on the unit) and the determined additional refrigerant amount.

6.6.3 To determine the additional refrigerant amount



**INFORMATION**

For final charge adjustment in a test laboratory, contact your dealer.



**INFORMATION**

Note down the amount of additional refrigerant that is calculated here, for later use on the additional refrigerant charge label. See "6.6.6 To fix the fluorinated greenhouse gases label" [▶ 61].

**Formula:**

$$R = [(X_1 \times \text{Ø}15.9) \times 0.18 + (X_2 \times \text{Ø}12.7) \times 0.12 + (X_3 \times \text{Ø}9.5) \times 0.059 + (X_4 \times \text{Ø}6.4) \times 0.022]$$

**R** Additional refrigerant to be charged [in kg and rounded off to 1 decimal place]

**X<sub>1...4</sub>** Total length [m] of liquid piping size at **Øa**

**Metric piping.** When using metric piping, replace the weight factors in the formula by the ones from the following table:

Inch piping		Metric piping	
Piping	Weight factor	Piping	Weight factor
Ø6.4 mm	0.022	Ø6 mm	0.018

Inch piping		Metric piping	
Piping	Weight factor	Piping	Weight factor
∅9.5 mm	0.059	∅10 mm	0.065
∅12.7 mm	0.12	∅12 mm	0.097
∅15.9 mm	0.18	∅15 mm	0.16

**Connection ratio requirements.** When selecting indoor units, the connection ratio must comply with the following requirements. For more information, see the technical engineering data.

Indoor units	Total CR <sup>(a)</sup>	CR per type <sup>(b)</sup>		
		VRV DX	RA DX	AHU
VRV DX only	50~130%	50~130%	—	—
RA DX only	80~130%	—	80~130%	—
VRV DX + AHU	50~110%	50~110%	—	0~60%
AHU only (EKEQ+ EKEXV) Pair + multi	90~110%	—	—	90~110%
AHU only (EKEACBVE+ EKEXVA) Pair + multi	75 <sup>(c)</sup> ~110%	—	—	75 <sup>(c)</sup> ~110%

<sup>(a)</sup> Total CR = Total indoor unit capacity connection ratio

<sup>(b)</sup> CR per type = Allowable capacity connection ratio per indoor unit type

<sup>(c)</sup> Additional restrictions might apply for connection ratio lower than 75% (65~110%). Please refer to the EKEA+EKEXVA manual.

#### 6.6.4 To charge refrigerant

To speed up the refrigerant charging process, it is in case of larger systems recommended to first pre-charge a portion of refrigerant through the liquid line before proceeding with the manual charging. It can be skipped, but charging will take longer then.

##### Pre-charging refrigerant

Pre-charging can be done without compressor operation, by connecting the refrigerant bottle to the service port of the liquid stop valve.

- 1 Connect as shown. Make sure that all outdoor unit stop valves, as well as valve A are closed.

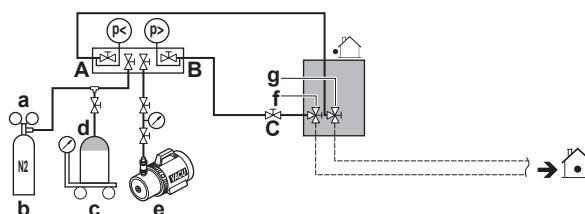

- a Pressure reducing valve
- b Nitrogen
- c Weighing scales
- d Refrigerant R410A tank (siphon system)
- e Vacuum pump
- f Liquid line stop valve
- g Gas line stop valve

- A Valve A
- B Valve B
- C Valve C

- 2 Open valves C and B.
- 3 Pre-charge refrigerant until the determined additional refrigerant amount is reached or pre-charging is not possible anymore, and then close valves C and B.
- 4 Do one of the following:

If	Then
The determined additional refrigerant amount is <b>reached</b>	Disconnect the manifold from the liquid line. You do not have to perform the "Charging refrigerant (in manual additional refrigerant charge mode)" instructions.
<b>Too much</b> refrigerant is charged	Recover refrigerant. Disconnect the manifold from the liquid line. You do not have to perform the "Charging refrigerant (in manual additional refrigerant charge mode)" instructions.
The determined additional refrigerant amount is <b>not reached</b> yet	Disconnect the manifold from the liquid line. Continue with the "Charging refrigerant (in manual additional refrigerant charge mode)" instructions.

### Charging refrigerant (in manual additional refrigerant charge mode)

The remaining additional refrigerant charge can be charged by operating the outdoor unit by means of the manual additional refrigerant charge mode.

- 5 Connect as shown. Make sure valve A is closed.

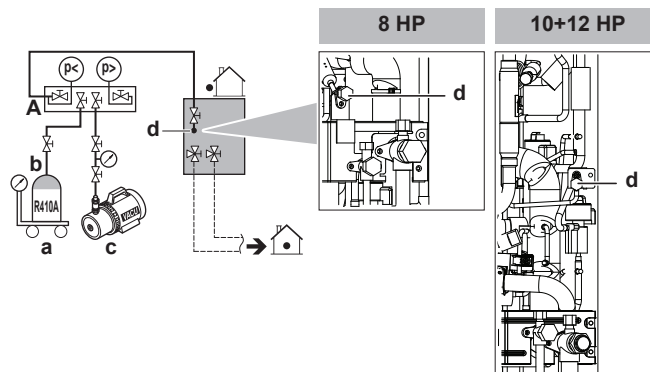

- a Weighing scales
- b Refrigerant R410A tank (siphon system)
- c Vacuum pump
- d Refrigerant charge port
- A Valve A



#### NOTICE

The refrigerant charging port is connected to the piping inside the unit. The unit's internal piping is already factory charged with refrigerant, so be careful when connecting the charge hose.

- 6 Open all outdoor unit stop valves. At this point, valve A must remain closed!
- 7 Take all the precautions mentioned in "7 Configuration" [▶ 71] and "8 Commissioning" [▶ 91] into account.

- 8 Turn on the power of the indoor units and outdoor unit.
- 9 Activate setting [2-20] to start the manual additional refrigerant charge mode. For details, see "[7.1.8 Mode 2: field settings](#)" [▶ 80].

**Result:** The unit will start operation.



#### INFORMATION

The manual refrigerant charge operation will automatically stop within 30 minutes. If charging is not completed after 30 minutes, perform the additional refrigerant charging operation again.



#### INFORMATION

- When a malfunction is detected during the procedure (e.g., in case of closed stop valve), a malfunction code will be displayed. In that case, refer to "[6.6.5 Error codes when charging refrigerant](#)" [▶ 61] and solve the malfunction accordingly. Resetting the malfunction can be done by pushing BS3. You can restart the "Charging" instructions.
- Aborting the manual refrigerant charge is possible by pushing BS3. The unit will stop and return to idle condition.

- 10 Open valve A.
- 11 Charge refrigerant until the remaining determined additional refrigerant amount is added, and then close valve A.
- 12 Press BS3 to stop the manual additional refrigerant charge mode.



#### NOTICE

Make sure to open all stop valves after (pre-) charging the refrigerant. Operating with the stop valves closed will damage the compressor.



#### NOTICE

After adding the refrigerant, do not forget to close the lid of the refrigerant charging port. The tightening torque for the lid is 11.5 to 13.9 N•m.

### 6.6.5 Error codes when charging refrigerant



#### INFORMATION

If a malfunction occurs:

- In case of RXYSQ8: The error code is displayed on the user interface of the indoor unit.
- In case of RXYSQ10+12: The error code is displayed on the outdoor unit's 7-segments display and on the user interface of the indoor unit.

If a malfunction occurs, close valve A immediately. Confirm the malfunction code and take corresponding action, "[11.3 Solving problems based on error codes](#)" [▶ 101].

### 6.6.6 To fix the fluorinated greenhouse gases label

- 1 Fill in the label as follows:

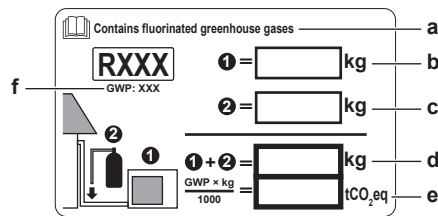

- a** If a multilingual fluorinated greenhouse gases label is delivered with the unit (see accessories), peel off the applicable language and stick it on top of **a**.
- b** Factory refrigerant charge: see unit name plate
- c** Additional refrigerant amount charged
- d** Total refrigerant charge
- e** **Quantity of fluorinated greenhouse gases** of the total refrigerant charge expressed as tonnes CO<sub>2</sub> equivalent.
- f** GWP = Global Warming Potential



#### NOTICE

Applicable legislation on **fluorinated greenhouse gases** requires that the refrigerant charge of the unit is indicated both in weight and CO<sub>2</sub> equivalent.

**Formula to calculate the quantity in CO<sub>2</sub> equivalent tonnes:** GWP value of the refrigerant × total refrigerant charge [in kg] / 1000

Use the GWP value mentioned on the refrigerant charge label.

- 2 Fix the label on the inside of the outdoor unit. There is a dedicated place for it on the wiring diagram label.

## 6.7 Connecting the electrical wiring

### 6.7.1 About connecting the electrical wiring

#### Typical workflow

Connecting the electrical wiring typically consists of the following stages:

- 1 Making sure the power supply system complies with the electrical specifications of the units.
- 2 Connecting the electrical wiring to the outdoor unit.
- 3 Connecting the electrical wiring to the indoor units.
- 4 Connecting the main power supply.

#### Precautions when connecting the electrical wiring



#### DANGER: RISK OF ELECTROCUTION



#### WARNING

All field wiring and components **MUST** be installed by a licensed electrician and **MUST** comply with the applicable legislation.



#### WARNING

If **NOT** factory installed, a main switch or other means for disconnection, having a contact separation in all poles providing full disconnection under overvoltage category III condition, **MUST** be installed in the fixed wiring.

**WARNING**

- ONLY use copper wires.
- Make sure the field wiring complies with the national wiring regulations.
- All field wiring MUST be performed in accordance with the wiring diagram supplied with the product.
- NEVER squeeze bundled cables and make sure they do NOT come in contact with the piping and sharp edges. Make sure no external pressure is applied to the terminal connections.
- Make sure to install earth wiring. Do NOT earth the unit to a utility pipe, surge absorber, or telephone earth. Incomplete earth may cause electrical shock.
- Make sure to use a dedicated power circuit. NEVER use a power supply shared by another appliance.
- Make sure to install the required fuses or circuit breakers.
- Make sure to install an earth leakage protector. Failure to do so may cause electrical shock or fire.
- When installing the earth leakage protector, make sure it is compatible with the inverter (resistant to high frequency electric noise) to avoid unnecessary opening of the earth leakage protector.

Install power cables at least 1 meter away from televisions or radios to prevent interference. Depending on the radio waves, a distance of 1 meter may NOT be sufficient.

**WARNING**

- After finishing the electrical work, confirm that each electrical component and terminal inside the switch box is connected securely.
- Make sure all covers are closed before starting up the unit.

**NOTICE**

Do NOT operate the unit until the refrigerant piping is complete. Running the unit before the piping is ready will break the compressor.

**NOTICE**

If the power supply has a missing or wrong N-phase, equipment will break down.

**NOTICE**

Do NOT install a phase advancing capacitor, because this unit is equipped with an inverter. A phase advancing capacitor will reduce performance and may cause accidents.

**NOTICE**

NEVER remove a thermistor, sensor, etc., when connecting power wiring and transmission wiring. (If operated without thermistor, sensor, etc., the compressor may break down.)



**NOTICE**

- The reversed phase protection detector of this product only functions when the product starts up. Consequently reversed phase detection is not performed during normal operation of the product.
- The reversed phase protection detector is designed to stop the product in the event of an abnormality when the product is started up.
- Replace 2 of the 3 phases (L1, L2, and L3) during reverse-phase protection abnormality.

**Field wiring: Overview**

Field wiring consists of:

- power supply (including earth),
- Interconnection wiring between communication box and outdoor unit,
- RS-485 interconnection wiring between communication box and monitoring system.



**NOTICE**

- Keep the power line and transmission line apart from each other. Transmission wiring and power supply wiring may cross, but may NOT run parallel.
- In order to avoid any electrical interference, the distance between both wirings should ALWAYS be at least 50 mm.

**Transmission wiring**

The transmission wiring outside the unit should be wrapped and routed together with the field piping.

<b>Transmission wiring specification and limits<sup>(a)</sup></b>	
Vinyl cords with 0.75 to 1.25 mm <sup>2</sup> sheath or cables (2-core wires)	
Maximum number of branches for unit-to-unit cabling	9
Maximum wiring length (distance between outdoor and furthest indoor unit)	300 m
Total wiring length (sum of distances between outdoor and all indoor units)	600 m

<sup>(a)</sup> If the total interconnection wiring exceeds these limits, communication errors might occur.

No secondary branchings are allowed after any transmission wire branching.

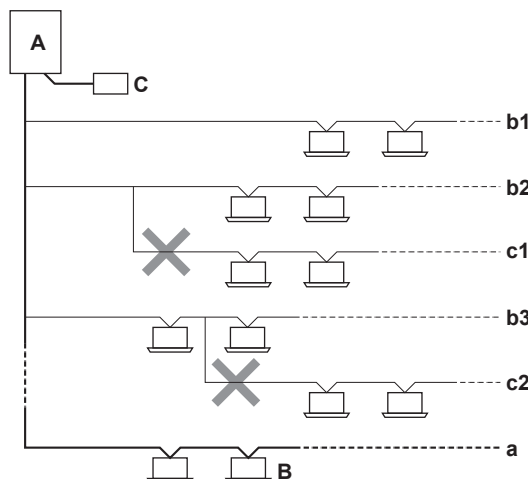



- A** Outdoor unit
- B** Indoor unit
- C** Central user interface (etc...)
- a** Main line
- b1, b2, b3** Branch lines
- c1, c2** No branch is allowed after branch

**Example:****INFORMATION**

The following figures are examples and may NOT completely match your system layout.

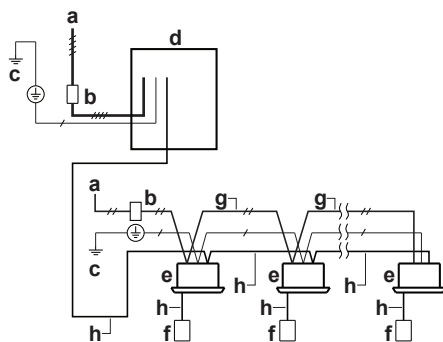

- a** Field power supply (with earth leakage protector)
- b** Main switch
- c** Earth connection
- d** Outdoor unit
- e** Indoor unit
- f** User interface
- g** Power supply wiring (sheathed cable) (230 V)
- h** Transmission wiring (sheathed cable) (16 V)
- Power supply 3N~ 50 Hz
- Power supply 1~ 50 Hz
- Earth wiring

**Guidelines for making knockout holes****NOTICE**

Precautions when making knockout holes:

- Avoid damaging the casing.
- After making the knockout holes, we recommend you remove the burrs and paint the edges and areas around the edges using repair paint to prevent rusting.
- When passing electrical wiring through the knockout holes, wrap the wiring with protective tape to prevent damage.

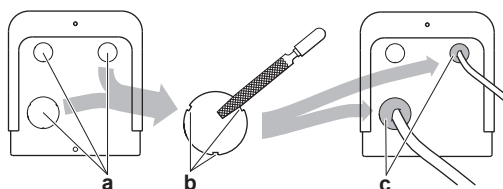

- a** Knockout hole
- b** Burr
- c** Sealant etc.

**Guidelines when connecting the electrical wiring**



**NOTICE**

We recommend using solid (single-core) wires. If stranded wires are used, slightly twist the strands to consolidate the end of the conductor for either direct use in the terminal clamp or insertion in a round crimp-style terminal.

**To prepare stranded conductor wire for installation**

**Method 1: Twisting conductor**

- 1 Strip insulation (20 mm) from the wires.
- 2 Slightly twist the end of the conductor to create a "solid-like" connection.

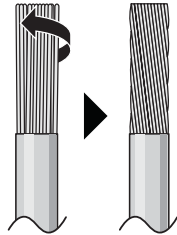

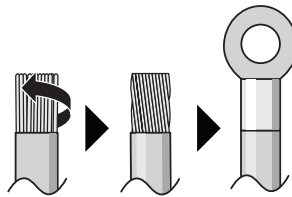

**Method 2: Using round crimp-style terminal (recommended)**

- 1 Strip insulation from wires and slightly twist the end of each wire.
- 2 Install a round crimp-style terminal on the end of the wire. Place the round crimp-style terminal on the wire up to the covered part and fasten the terminal with the appropriate tool.

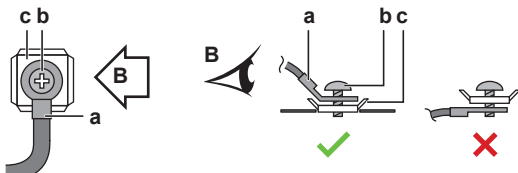

**Use the following methods for installing wires:**

Wire type	Installation method
Single-core wire Or Stranded conductor wire twisted to "solid-like" connection	<p><b>a</b> Curled wire (single-core or twisted stranded conductor wire)</p> <p><b>b</b> Screw</p> <p><b>c</b> Flat washer</p>

Wire type	Installation method
Stranded conductor wire with round crimp-style terminal	 <p> <b>a</b> Terminal  <b>b</b> Screw  <b>c</b> Flat washer   Allowed   NOT allowed </p>

### Tightening torques

In case of 8 HP:

Wiring	Screw size	Tightening torque (N•m)
Power supply wiring (power supply + shielded ground)	M5	2.2~2.7
Transmission wiring	M3	0.8~0.97

In case of 10+12 HP:

Wiring	Screw size	Tightening torque (N•m)
Power supply wiring (power supply + shielded ground)	M8	5.5~7.3
Transmission wiring	M3.5	0.8~0.97

### 6.7.2 To connect the electrical wiring to the outdoor unit



#### NOTICE

- Follow the wiring diagram (delivered with the unit, located at the inside of the service cover).
- Make sure the electrical wiring does NOT obstruct proper reattachment of the service cover.

- Remove the service cover. See "6.2.2 To open the outdoor unit" [▶ 41].
- Strip insulation (20 mm) from the wires.

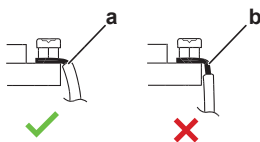

- Strip wire end to this point
- An excessive strip length may cause electrical shock or leakage

- Connect the transmission wiring as follows:

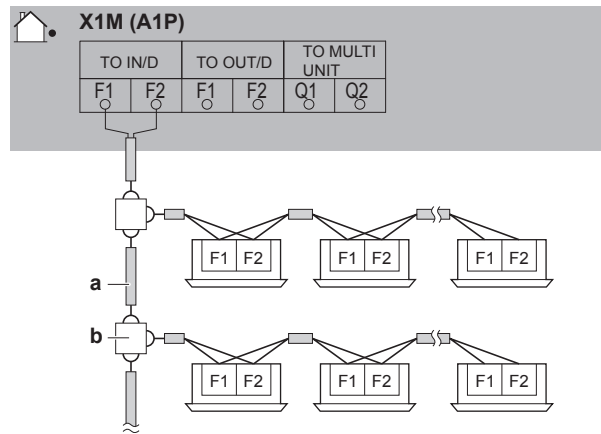

- a** Use the conductor of sheathed wire (2 wire) (no polarity)
- b** Terminal board (field supply)

**4** Connect the power supply as follows:

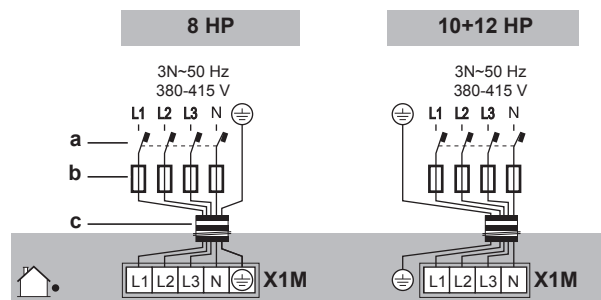

- a** Earth leakage circuit breaker
- b** Fuse
- c** Power supply cable

**5** Fix the cables (power supply and transmission wiring) with cable ties.

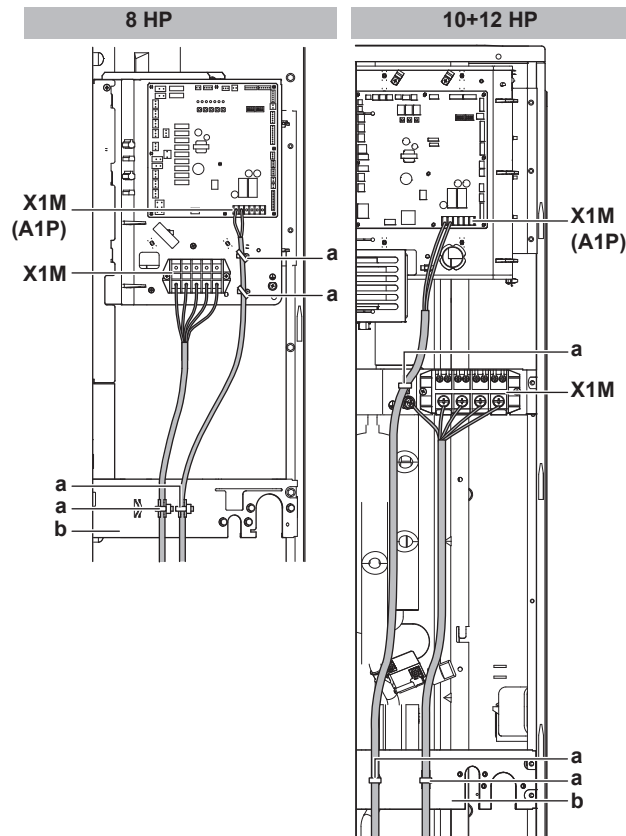

- a** Cable tie
- b** Attachment plate
- X1M** Power supply

**X1M (A1P)** Transmission wiring**6** Route the wiring through the frame and connect it to it.

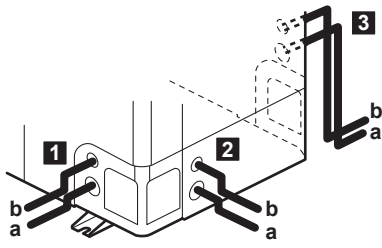
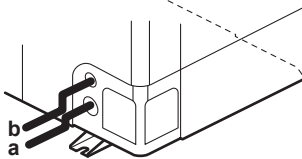
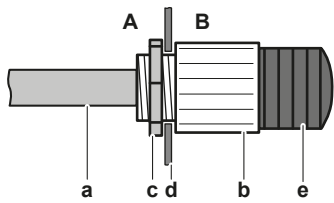
<p>Routing through the frame</p>	<p>In case of RXYSQ8: Choose one of the 3 possibilities:</p>  <p>In case of RXYSQ10+12:</p>  <p><b>a</b> Power supply cable <b>b</b> Transmission wiring cable</p>
<p>Connecting to the frame</p>	<p>When cables are routed from the unit, a protection sleeve for the conduits (PG insertions) can be inserted at the knockout hole.</p> <p>When you do not use a wire conduit, protect the wires with vinyl tubes to prevent the edge of the knockout hole from cutting the wires.</p>  <p><b>A</b> Inside of the outdoor unit <b>B</b> Outside of the outdoor unit</p> <p><b>a</b> Wire <b>b</b> Bush <b>c</b> Nut <b>d</b> Frame <b>e</b> Hose</p>

**NOTICE**

Precautions when making knockout holes:

- Avoid damaging the casing and underlying piping.
- After making the knockout holes, we recommend to remove the burrs and paint the edges and areas around the edges using repair paint to prevent rusting.
- When passing electrical wiring through the knockout holes, wrap the wiring with protective tape to prevent damage.

**7** Reattach the service cover. See "[6.8.2 To close the outdoor unit](#)" [▶ 70].**8** Connect an earth leakage circuit breaker and fuse to the power supply line.

## 6.8 Finishing the outdoor unit installation

### 6.8.1 To finish the interconnection wiring

After installing the interconnection wiring, wrap it along with the onsite refrigerant piping using finishing tape, as shown in the illustration below.

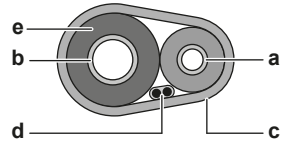

- a** Liquid piping
- b** Gas piping
- c** Finishing tape
- d** Interconnection cable (F1/F2)
- e** Insulation

### 6.8.2 To close the outdoor unit



#### NOTICE

When closing the outdoor unit cover, make sure that the tightening torque does NOT exceed 4.1 N•m.

8 HP

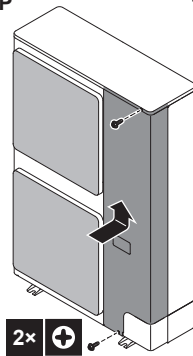

10+12 HP

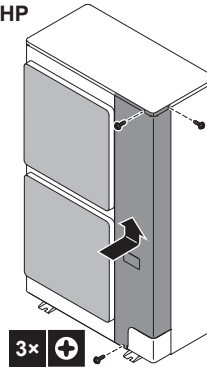

# 7 Configuration



## DANGER: RISK OF ELECTROCUTION



## INFORMATION

It is important that all information in this chapter is read sequentially by the installer and that the system is configured as applicable.

## In this chapter

7.1	Making field settings.....	71
7.1.1	About making field settings .....	71
7.1.2	To access the field setting components .....	72
7.1.3	Field setting components .....	72
7.1.4	To access mode 1 or 2 .....	74
7.1.5	To use mode 1.....	75
7.1.6	To use mode 2.....	76
7.1.7	Mode 1 (and default situation): Monitoring settings.....	77
7.1.8	Mode 2: field settings .....	80
7.1.9	To connect the PC configurator to the outdoor unit .....	84
7.2	Energy saving and optimum operation.....	84
7.2.1	Available main operation methods.....	85
7.2.2	Available comfort settings .....	86
7.2.3	Example: Automatic mode during cooling .....	88
7.2.4	Example: Automatic mode during heating.....	89

## 7.1 Making field settings

### 7.1.1 About making field settings

To configure the heat pump system, you must give input to the outdoor unit's main PCB (A1P). This involves the following field setting components:

- Push buttons to give input to the PCB
- A display to read feedback from the PCB

Field settings are defined by their mode, setting and value. Example: [2-8]=4.

#### PC configurator

For VRV IV-S heat pump system it is alternatively possible to make several commissioning field settings through a personal computer interface (for this, option EKPCAB\* is required). The installer can prepare the configuration (off-site) on PC and afterwards upload the configuration to the system.

See also: "7.1.9 To connect the PC configurator to the outdoor unit" [▶ 84].

#### Mode 1 and 2

Mode	Description
Mode 1 (monitoring settings)	Mode 1 can be used to monitor the current situation of the outdoor unit. Some field setting contents can be monitored as well.

Mode	Description
Mode 2 (field settings)	<p>Mode 2 is used to change the field settings of the system. Consulting the current field setting value and changing the current field setting value is possible.</p> <p>In general, normal operation can be resumed without special intervention after changing field settings.</p> <p>Some field settings are used for special operation (e.g., one time operation, recovery/vacuumping setting, manual adding refrigerant setting, etc.). In such a case, it is required to abort the special operation before normal operation can restart. It will be indicated in below explanations.</p>

7.1.2 To access the field setting components

See "6.2.2 To open the outdoor unit" [▶ 41].

7.1.3 Field setting components



**NOTICE**

The DIP switches (DS1 and/or DS2 on A1P) are not used. Do NOT change the factory setting.

The components to make field settings differ depending on the model.

Model	Field setting components
RXYSQ8	<ul style="list-style-type: none"> <li>Push buttons (BS1~BS5)</li> <li>7-LEDs display (H1P~H7P)</li> <li>H8P: LED for indication during initialisation</li> </ul>
RXYSQ10+12	<ul style="list-style-type: none"> <li>Push buttons (BS1~BS3)</li> <li>7-segments display (888)</li> </ul>

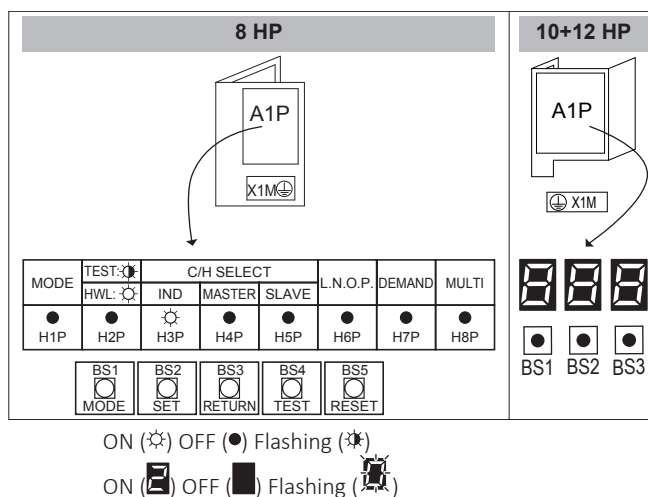

**Push buttons**

Use the push buttons to make the field settings. Operate the push buttons with an insulated stick (such as a closed ball-point pen) to avoid touching live parts.



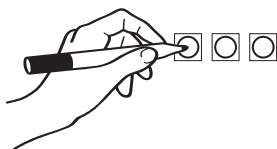

The push buttons differ depending on the model.

Model	Push buttons
RXYSQ8	BS1: MODE: For changing the set mode BS2: SET: For field setting BS3: RETURN: For field setting BS4: TEST: For test operation BS5: RESET: For resetting the address when the wiring is changed or when an additional indoor unit is installed
RXYSQ10+12	BS1: MODE: For changing the set mode BS2: SET: For field setting BS3: RETURN: For field setting

### Display

The display gives feedback about the field settings, which are defined as [Mode-Setting]=Value.

The display differs depending on the model.

Model	Display
RXYSQ8	7-LEDs display H1P: Shows the mode H2P~H7P: Shows the settings and values, represented in binary code H8P: NOT used for field settings, but used during initialisation
RXYSQ10+12	7-segments display (888)

### Example:

$[H1P - 32 + 16 + 8 + 4 + 2 + 1]$ H1P H2P H3P H4P H5P H6P H7P		Description
 (H1P OFF)		Default situation
 (H1P flashing)		Mode 1
 (H1P ON)		Mode 2
 $0 + 0 + 8 + 0 + 0 + 0$ (H2P~H7P = binary 8)		Setting 8 (in mode 2)
 $0 + 0 + 0 + 4 + 0 + 0$ (H2P~H7P = binary 4)		Value 4 (in mode 2)

7.1.4 To access mode 1 or 2

After the units are turned ON, the display goes to its default situation. From there, you can access mode 1 and mode 2.

**Initialisation: default situation**

**NOTICE**  
Turn ON the power 6 hours before operation in order to have power running to the crankcase heater and to protect the compressor.

Turn on the power supply of the outdoor unit and all indoor units. When the communication between indoor units and outdoor unit is established and normal, the display indication state will be as below (default situation when shipped from factory).

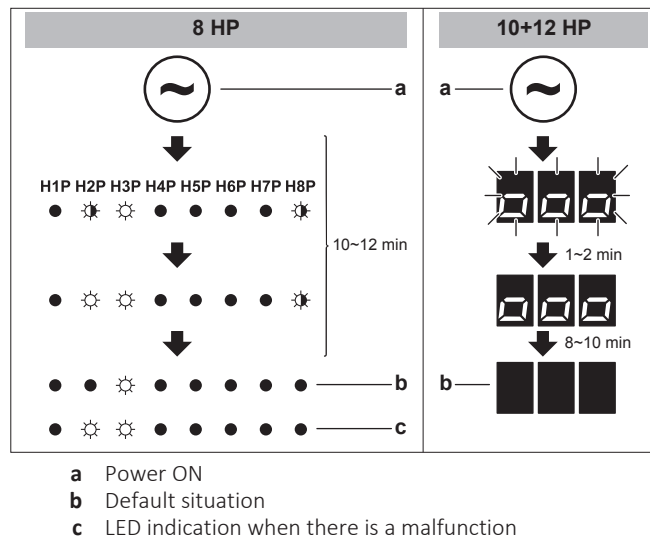

If the default situation is not displayed after 10~12 minutes, check the malfunction code on the indoor unit user interface (and in case of RXYSQ10+12 on the outdoor unit 7-segment display). Solve the malfunction code accordingly. First, check the communication wiring.

**Switching between modes**

Use BS1 to switch between the default situation, mode 1 and mode 2.

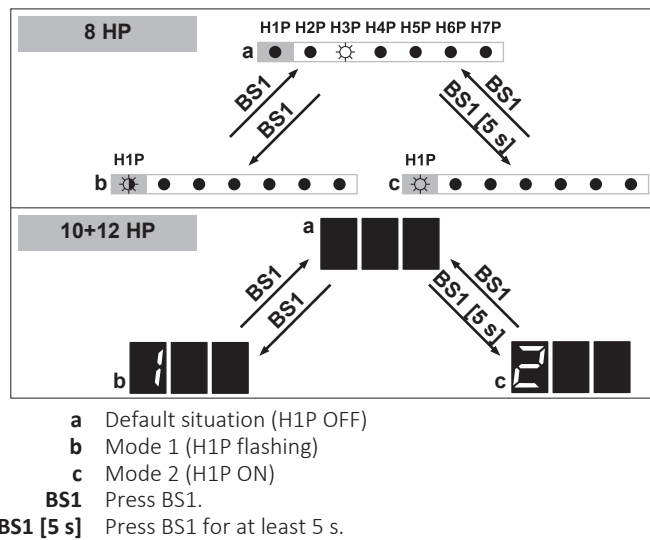

**INFORMATION**

If you get confused in the middle of the process, press BS1 to return to the default situation.

## 7.1.5 To use mode 1

In mode 1 (and in default situation) you can read out some information. How to do this differs depending on the model.

**Example: 7-LEDs display – Default situation**

(in case of RXYSQ8)

You can read out the status of low noise operation as follows:

#	Action	Button/display
1	Make sure the LEDs are showing the default situation.	 (H1P OFF)
2	Check the status of LED H6P.	 H6P OFF: Unit is currently not operating under low noise restrictions.
		 H6P ON: Unit is currently operating under low noise restrictions.

**Example: 7-LEDs display – Mode 1**

(in case of RXYSQ8)

You can read out setting [1-5] (= the total number of connected indoor units) as follows:

#	Action	Button/display
1	Start from the default situation.	
2	Select mode 1.	
3	Select setting 5. ("Xx" depends on the setting that you want to select.)	 (= binary 5)
4	Display the value of setting 5. (there are 8 indoor units connected)	 (= binary 8)
5	Quit mode 1.	

**Example: 7-segments display – Mode 1**

(in case of RXYSQ10+12)

You can read out setting [1-10] (= the total number of connected indoor units) as follows:

#	Action	Button/display
1	Start from the default situation.	
2	Select mode 1.	↓BS1 [1×] 
3	Select setting 10. ("Xx" depends on the setting that you want to select.)	↓BS2 [X×] 
4	Display the value of setting 10. (there are 8 indoor units connected)	↓BS3 [1×] 
5	Quit mode 1.	↓BS1 [1×] 

### 7.1.6 To use mode 2

In mode 2 you can make field settings to configure the system. How to do this differs slightly depending on the model.

#### Example: 7-LEDs display – Mode 2

(in case of RXYSQ8)

You can change the value of setting [2-8] (= T<sub>e</sub> target temperature during cooling operation) to 4 (= 8°C) as follows:

#	Action	Button/display
1	Start from the default situation.	H1P H2P H3P H4P H5P H6P H7P 
2	Select mode 2.	↓BS1 [5 s] 
3	Select setting 8. ("Xx" depends on the setting that you want to select.)	↓BS2 [X×]  (= binary 8)
4	Select value 4 (= 8°C). <b>a:</b> Display the current value. <b>b:</b> Change to 4. ("Xx" depends on the current value, and the value that you want to select.) <b>c:</b> Enter the value in the system. <b>d:</b> Confirm. The system starts operating according to the setting.	a ↓BS3 [1×]  b ↓BS2 [X×]  c ↓BS3 [1×]  d ↓BS3 [1×] 
5	Quit mode 2.	↓BS1 [1×] 

#### Example: 7-segments display – Mode 2

(in case of RXYSQ10+12)

You can change the value of setting [2-8] (= T<sub>e</sub> target temperature during cooling operation) to 4 (= 8°C) as follows:

#	Action	Button/display
1	Start from the default situation.	
2	Select mode 2.	↓BS1 [5 s] 
3	Select setting 8. ("Xx" depends on the setting that you want to select.)	↓BS2 [Xx] 
4	Select value 4 (= 8°C). <b>a:</b> Display the current value. <b>b:</b> Change to 4. ("Xx" depends on the current value, and the value that you want to select.) <b>c:</b> Enter the value in the system. <b>d:</b> Confirm. The system starts operating according to the setting.	a BS3 [1x]  b BS2 [Xx] c BS3 [1x] d BS3 [1x] 
5	Quit mode 2.	↓BS1 [1x] 

### 7.1.7 Mode 1 (and default situation): Monitoring settings



In mode 1 (and in default situation) you can read out some information. What you can read out differs depending on the model.

#### 7-LEDs display – Default situation (H1P OFF)

(in case of RXYSQ8)

You can read out the following information:





	Value / Description
H6P	Shows the status of low noise operation.
OFF	● ● ☼ ● ● ● ● Unit is currently not operating under low noise restrictions.
ON	● ● ☼ ● ● ☼ ● Unit is currently operating under low noise restrictions.
<p>Low noise operation reduces the sound generated by the unit compared to nominal operating conditions.</p> <p>Low noise operation can be set in mode 2. There are two methods to activate low noise operation of the outdoor unit system.</p> <ul style="list-style-type: none"> <li>The first method is to enable an automatic low noise operation during night time by field setting. The unit will operate at the selected low noise level during the selected time frames.</li> <li>The second method is to enable low noise operation based on an external input. For this operation an optional accessory is required.</li> </ul>	

Value / Description	
H7P	Shows the status of power consumption limitation operation.
OFF	 <p>Unit is currently not operating under power consumption limitations.</p>
ON	 <p>Unit is currently operating under power consumption limitation.</p>
<p>Power consumption limitation reduces the power consumption of the unit compared to nominal operating conditions.</p> <p>Power consumption limitation can be set in mode 2. There are two methods to activate power consumption limitation of the outdoor unit system.</p> <ul style="list-style-type: none"> <li>▪ The first method is to enable a forced power consumption limitation by field setting. The unit will always operate at the selected power consumption limitation.</li> <li>▪ The second method is to enable power consumption limitation based on an external input. For this operation an optional accessory is required.</li> </ul>	

### 7-LEDs display – Mode 1 (H1P flashing)

(in case of RXYSQ8)

You can read out the following information:

Setting (H1P H2P H3P H4P H5P H6P H7P)	Value / Description
[1-5] 	<p>It can be convenient to check if the total number of indoor units which are installed match the total number of indoor units which are recognised by the system. In case there is a mismatch, it is advised to check the communication wiring path between outdoor and indoor units (F1/F2 communication line).</p> <p>When the latest malfunction codes were reset by accident on an indoor unit user interface, they can be checked again through this monitoring settings.</p> <p>For the content or reason behind the malfunction code see "<a href="#">11.3 Solving problems based on error codes</a>" [<a href="#">▶ 101</a>], where most relevant malfunction codes are explained. Detailed information about malfunction codes can be consulted in the service manual of this unit.</p> <p>To obtain more detailed information about the malfunction code, press BS2 up to 3 times.</p>
Shows the total number of connected indoor units.	
[1-14] 	
[1-15] 	
Shows the 2nd last malfunction code.	
[1-16] 	
Shows the 3rd last malfunction code.	

**7-segments display – Mode 1**

(in case of RXYSQ10+12)

You can read out the following information:

Setting	Value / Description	
[1-1] Shows the status of low noise operation.	0	Unit is currently not operating under low noise restrictions.
	1	Unit is currently operating under low noise restrictions.
	Low noise operation reduces the sound generated by the unit compared to nominal operating conditions. Low noise operation can be set in mode 2. There are two methods to activate low noise operation of the outdoor unit system. <ul style="list-style-type: none"> <li>▪ The first method is to enable an automatic low noise operation during night time by field setting. The unit will operate at the selected low noise level during the selected time frames.</li> <li>▪ The second method is to enable low noise operation based on an external input. For this operation an optional accessory is required.</li> </ul>	
[1-2] Shows the status of power consumption limitation operation.	0	Unit is currently not operating under power consumption limitations.
	1	Unit is currently operating under power consumption limitation.
	Power consumption limitation reduces the power consumption of the unit compared to nominal operating conditions. Power consumption limitation can be set in mode 2. There are two methods to activate power consumption limitation of the outdoor unit system. <ul style="list-style-type: none"> <li>▪ The first method is to enable a forced power consumption limitation by field setting. The unit will always operate at the selected power consumption limitation.</li> <li>▪ The second method is to enable power consumption limitation based on an external input. For this operation an optional accessory is required.</li> </ul>	
[1-5] Shows the current $T_e$ target parameter position.	For more information, see setting [2-8].	
[1-6] Shows the current $T_c$ target parameter position.	For more information, see setting [2-9].	

Setting	Value / Description
[1-10] Shows the total number of connected indoor units.	It can be convenient to check if the total number of indoor units which are installed match the total number of indoor units which are recognised by the system. In case there is a mismatch, it is advised to check the communication wiring path between outdoor and indoor units (F1/F2 communication line).
[1-17] Shows the latest malfunction code.	When the latest malfunction codes were reset by accident on an indoor unit user interface, they can be checked again through this monitoring settings.
[1-18] Shows the 2nd last malfunction code.	For the content or reason behind the malfunction code see " <a href="#">11.3 Solving problems based on error codes</a> " [▶ 101], where most relevant malfunction codes are explained. Detailed information about malfunction codes can be consulted in the service manual of this unit.
[1-19] Shows the 3rd last malfunction code.	
[1-40] Shows the current cooling comfort setting.	For more information, see setting [2-81].
[1-41] Shows the current heating comfort setting.	For more information, see setting [2-82].

### 7.1.8 Mode 2: field settings

In mode 2 you can make field settings to configure the system. The settings differ slightly depending on the model.















- **888**: When using the 7-segments display (RXYSQ10+12)
- **H1P H2P H3P H4P H5P H6P H7P**: When using the 7-LEDs display (RXYSQ8) (the LEDs give a binary representation of the setting/value number)











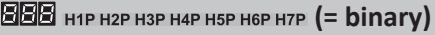











For more information and advice about the impact of the following settings, see "[7.2 Energy saving and optimum operation](#)" [▶ 84]:

















- In case of RXYSQ8: settings [2-8], [2-9], [2-39] and [2-43]
- In case of RXYSQ10+12: settings [2-8], [2-9], [2-81] and [2-82]

Setting <b>888</b> H1P H2P H3P H4P H5P H6P H7P (= binary)	Value		
	<b>888</b>	H1P H2P H3P H4P H5P H6P H7P	Description
[2-8] ☀ ● ● ☀ ● ● ● T <sub>e</sub> target temperature during cooling operation.	0 (default )	☀ ● ● ● ● ☀ ☀ (= binary 3) (default)	Auto
	2	☀ ● ● ● ● ☀ ●	6°C
	4	☀ ● ● ● ☀ ● ●	8°C
	5	☀ ● ● ● ☀ ● ☀	9°C
	6	☀ ● ● ● ☀ ☀ ●	10°C
	7	☀ ● ● ● ☀ ☀ ☀	11°C



Setting  H1P H2P H3P H4P H5P H6P H7P (= binary)	Value		
		H1P H2P H3P H4P H5P H6P H7P	Description
[2-9]  T <sub>c</sub> target temperature during heating operation.	0 (default )	 (= binary 1) (default)	Auto
	3	 (= binary 4)	43°C
	6	 (= binary 2)	46°C
[2-12]  Enable the low noise function and/or power consumption limitation via external control adaptor (DTA104A61/62). If the system needs to be running under low noise operation or under power consumption limitation conditions when an external signal is sent to the unit, this setting should be changed. This setting will only be effective when the optional external control adaptor (DTA104A61/62) is installed in the indoor unit.	0 (default )	 (= binary 1) (default)	Deactivated.
	1	 (= binary 2)	Activated.
[2-18]  Fan high static pressure setting. In order to increase the static pressure the outdoor unit fan is delivering, this setting should be activated. For details about this setting, see technical specifications.	0 (default )	 (= binary 1) (default)	Deactivated.
	1	 (= binary 2)	Activated.
[2-20]  Manual additional refrigerant charge. In order to add the additional refrigerant charge amount in a manual way (without automatic refrigerant charging functionality), following setting should be applied.	0 (default )	 (= binary 1) (default)	Deactivated.
	1	 (= binary 2)	Activated. To stop the manual additional refrigerant charge operation (when the required additional refrigerant amount is charged), push BS3. If this function was not aborted by pushing BS3, the unit will stop its operation after 30 minutes. If 30 minutes was not sufficient to add the needed refrigerant amount, the function can be reactivated by changing the field setting again.

Setting  (= binary)	Value			
		H1P H2P H3P H4P H5P H6P H7P	Description	
[2-21]  Refrigerant recovery/vacuumping mode. In order to achieve a free pathway to reclaim refrigerant out of the system or to remove residual substances or to vacuum the system it is necessary to apply a setting which will open required valves in the refrigerant circuit so the reclaim of refrigerant or vacuumping process can be done properly.	0 (default)	 (= binary 1) (default)	Deactivated.	
	1	 (= binary 2)	Activated. To stop the refrigerant recovery/vacuumping mode, push BS1 (in case of RXYSQ8) or BS3 (in case of RXYSQ10+12). If it is not pushed, the system will remain in refrigerant recovery/vacuumping mode.	
[2-22]  Automatic low noise setting and level during night time. By changing this setting, you activate the automatic low noise operation function of the unit and define the level of operation. Depending on the chosen level, the noise level will be lowered. The start and stop moments for this function are defined under setting [2-26] and [2-27].	0 (default)	 (default)	Deactivated	
	1		Level 1	Level 3<Level 2<Level 1
	2		Level 2	
	3		Level 3	
[2-25]  Low noise operation level via the external control adaptor. If the system needs to be running under low noise operation conditions when an external signal is sent to the unit, this setting defines the level of low noise that will be applied. This setting will only be effective when the optional external control adaptor (DTA104A61/62) is installed and the setting [2-12] was activated.	1		Level 1	Level 3<Level 2<Level 1
	2 (default)	 (default)	Level 2	
	3	 (= binary 4)	Level 3	
[2-26]  Low noise operation start time. This setting is used in conjunction with setting [2-22].	1		20h00	
	2 (default)	 (default)	22h00	
	3	 (= binary 4)	24h00	
[2-27]  Low noise operation stop time. This setting is used in conjunction with setting [2-22].	1		6h00	
	2		7h00	
	3 (default)	 (= binary 4) (default)	8h00	

Setting  H1P H2P H3P H4P H5P H6P H7P (= binary)	Value		
	 H1P H2P H3P H4P H5P H6P H7P		Description
<p>[2-30] </p> <p>Power consumption limitation level (step 1) via the external control adaptor (DTA104A61/62).</p> <p>If the system needs to be running under power consumption limitation conditions when an external signal is sent to the unit, this setting defines the level power consumption limitation that will be applied for step 1. The level is according to the table.</p>	1		60%
	2	—	65%
	3 (default )	 (= binary 2) (default)	70%
	4	—	75%
	5	 (= binary 4)	80%
	6	—	85%
	7	—	90%
	8	—	95%
<p>[2-31] </p> <p>Power consumption limitation level (step 2) via the external control adaptor (DTA104A61/62).</p> <p>If the system needs to be running under power consumption limitation conditions when an external signal is sent to the unit, this setting defines the level power consumption limitation that will be applied for step 2. The level is according to the table.</p>	—	 (= binary 1)	30%
	1 (default )	 (= binary 2) (default)	40%
	2	 (= binary 4)	50%
	3	—	55%
<p>[2-32] </p> <p>Forced, all time, power consumption limitation operation (no external control adaptor is required to perform power consumption limitation).</p> <p>If the system always needs to be running under power consumption limitation conditions, this setting activates and defines the level power consumption limitation that will be applied continuously. The level is according to the table.</p>	0 (default )	 (= binary 1) (default)	Function not active.
	1	 (= binary 2)	Follows [2-30] setting.
	2	 (= binary 4)	Follows [2-31] setting.
<p>[2-41] </p> <p>Type of indoor units</p> <p>After changing this setting, you have to power OFF the system, wait for 20 s, and then power ON again. If not, the setting will not be processed and malfunction codes might occur.</p> <p>This setting is only applicable in case of RXYSQ8. In case of RXYSQ10+12, the type of indoor units is detected automatically.</p>	—	 (= binary 1) (default)	VRV DX indoor units installed
	—	 (= binary 2)	RA DX indoor units installed

Setting [H1P H2P H3P H4P H5P H6P H7P] (= binary)	Value		
	[H1P H2P H3P H4P H5P H6P H7P]	[H1P H2P H3P H4P H5P H6P H7P]	Description
[2-81] (in case of [H1P H2P H3P H4P H5P H6P H7P]) [H1P H2P H3P H4P H5P H6P H7P] (= binary [2-39]) (in case of [H1P H2P H3P H4P H5P H6P H7P]) Cooling comfort setting. This setting is used in conjunction with setting [2-8].	0	[H1P H2P H3P H4P H5P H6P H7P]	Eco
	1 (default)	[H1P H2P H3P H4P H5P H6P H7P] (default)	Mild
	2	[H1P H2P H3P H4P H5P H6P H7P]	Quick
	3	[H1P H2P H3P H4P H5P H6P H7P]	Powerful
[2-82] (in case of [H1P H2P H3P H4P H5P H6P H7P]) [H1P H2P H3P H4P H5P H6P H7P] (= binary [2-43]) (in case of [H1P H2P H3P H4P H5P H6P H7P]) Heating comfort setting. This setting is used in conjunction with setting [2-9].	0	[H1P H2P H3P H4P H5P H6P H7P]	Eco
	1 (default)	[H1P H2P H3P H4P H5P H6P H7P] (default)	Mild
	2	[H1P H2P H3P H4P H5P H6P H7P]	Quick
	3	[H1P H2P H3P H4P H5P H6P H7P]	Powerful

7.1.9 To connect the PC configurator to the outdoor unit

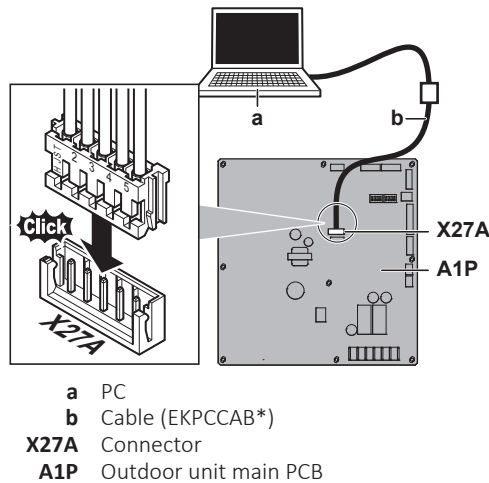

7.2 Energy saving and optimum operation

This heat pump system is equipped with advanced energy saving functionality. Depending on the priority, emphasis can be put on energy saving or comfort level. Several parameters can be selected, resulting in the optimal balance between energy consumption and comfort for the particular application.

Several patterns are available and explained below. Modify the parameters to the needs of your building and to realize the best balance between energy consumption and comfort.

No matter which control is selected, variations on the behaviour of the system are still possible due to protection controls to keep the unit operating under reliable conditions. The intentional target, however, is fixed and will be used to obtain the best balance between energy consumption and comfort, depending on the application type.

## 7.2.1 Available main operation methods

**Basic**

The refrigerant temperature is fixed independent from the situation.

In case of RXYSQ8:

To activate this in...	Change...
Cooling operation	[2-8]=2
Heating operation	[2-9]=2

In case of RXYSQ10+12:

To activate this in...	Change...
Cooling operation	[2-8]=2
Heating operation	[2-9]=6

**Automatic**

The refrigerant temperature is set depending on the outdoor ambient conditions. As such adjusting the refrigerant temperature to match the required load (which is also related to the outdoor ambient conditions).

E.g., when your system is operating in cooling, you do not need as much cooling under low outdoor ambient temperatures (e.g., 25°C) as under high outdoor ambient temperatures (e.g., 35°C). Using this idea, the system automatically starts increasing its refrigerant temperature, automatically reducing the delivered capacity and increasing the system's efficiency.

E.g., when your system is operating in heating, you do not need as much heating under high outdoor ambient temperatures (e.g., 15°C) as under low outdoor ambient temperatures (e.g., -5°C). Using this idea, the system automatically starts decreasing its refrigerant temperature, automatically reducing the delivered capacity and increasing the system's efficiency.

In case of RXYSQ8:

To activate this in...	Change...
Cooling operation	[2-8]=3 (default)
Heating operation	[2-9]=1 (default)

In case of RXYSQ10+12:

To activate this in...	Change...
Cooling operation	[2-8]=0 (default)
Heating operation	[2-9]=0 (default)

**Hi-sensible/economic (cooling/heating)**

The refrigerant temperature is set higher/lower (cooling/heating) compared to basic operation. The focus under high sensible mode is comfort feeling for the customer.

The selection method of indoor units is important and has to be considered as the available capacity is not the same as under basic operation.

For details concerning to Hi-sensible applications, please contact your dealer.

To activate this in...	Change...
Cooling operation	[2-8] to the appropriate value, matching the requirements of the pre-designed system containing a high sensible solution.
Heating operation	[2-9] to the appropriate value, matching the requirements of the pre-designed system containing a high sensible solution.

In case of RXYSQ8:

[2-8]	T <sub>e</sub> target (°C)
4	8
5	9
6	10
7	11

In case of RXYSQ8:

[2-9]	T <sub>c</sub> target (°C)
4	43

In case of RXYSQ10+12:

[2-8]	T <sub>e</sub> target (°C)
4	8
5	9
6	10
7	11

In case of RXYSQ10+12:

[2-9]	T <sub>c</sub> target (°C)
3	43

### 7.2.2 Available comfort settings

For each of above modes a comfort level can be selected. The comfort level is related to the timing and the effort (energy consumption) which is put in achieving a certain room temperature by temporarily changing the refrigerant temperature to different values in order to achieve requested conditions more quickly.

#### Powerful

Overshoot (during heating operation) or undershoot (during cooling operation) is allowed compared to the requested refrigerant temperature, in order to achieve the required room temperature very fast. The overshoot is allowed from the start up moment.

When the request from the indoor units becomes more moderate, the system will eventually go to the steady state condition which is defined by the operation method above.

To activate this in...	Change...
Cooling operation	[2-81]=3 (in case of RXYSQ10+12). [2-39]=3 (in case of RXYSQ8). This setting is used in conjunction with setting [2-8].
Heating operation	[2-82]=3 (in case of RXYSQ10+12). [2-43]=3 (in case of RXYSQ8). This setting is used in conjunction with setting [2-9]

### Quick

Overshoot (during heating operation) or undershoot (during cooling operation) is allowed compared to the requested refrigerant temperature, in order to achieve the required room temperature very fast. The overshoot is allowed from the start up moment.

When the request from the indoor units becomes more moderate, the system will eventually go to the steady state condition which is defined by the operation method above.

To activate this in...	Change...
Cooling operation	[2-81]=2 (in case of RXYSQ10+12). [2-39]=2 (in case of RXYSQ8). This setting is used in conjunction with setting [2-8].
Heating operation	[2-82]=2 (in case of RXYSQ10+12). [2-43]=2 (in case of RXYSQ8). This setting is used in conjunction with setting [2-9].

### Mild

Overshoot (during heating operation) or undershoot (during cooling operation) is allowed compared to the requested refrigerant temperature, in order to achieve the required room temperature very fast. The overshoot is not allowed from the start up moment. The start up occurs under the condition which is defined by the operation mode above.

When the request from the indoor units becomes more moderate, the system will eventually go to the steady state condition which is defined by the operation method above.

**Note:** The start up condition is different from the powerful and quick comfort setting.

To activate this in...	Change...
Cooling operation	[2-81]=1 (in case of RXYSQ10+12). [2-39]=1 (in case of RXYSQ8). This setting is used in conjunction with setting [2-8].

To activate this in...	Change...
Heating operation	[2-82]=1 (in case of RXYSQ10+12). [2-43]=1 (in case of RXYSQ8). This setting is used in conjunction with setting [2-9].

**Eco**

The original refrigerant temperature target, which is defined by the operation method (see above) is kept without any correction, unless for protection control.

To activate this in...	Change...
Cooling operation	[2-81]=0 (in case of RXYSQ10+12). [2-39]=0 (in case of RXYSQ8). This setting is used in conjunction with setting [2-8].
Heating operation	[2-82]=0 (in case of RXYSQ10+12). [2-43]=0 (in case of RXYSQ8). This setting is used in conjunction with setting [2-9].

7.2.3 Example: Automatic mode during cooling

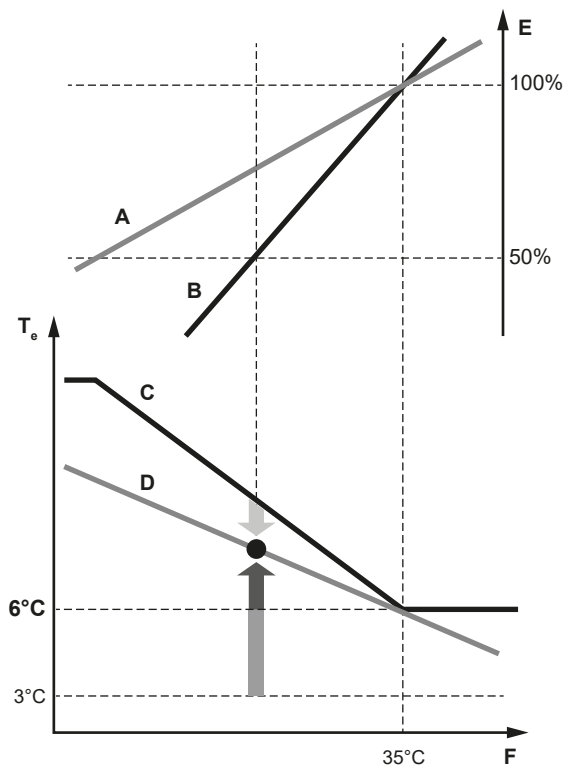

- A Actual load curve
- B Virtual load curve (initial capacity automatic mode)
- C Virtual target value (initial evaporation temperature value automatic mode)
- D Required evaporation temperature value
- E Load factor
- F Outside air temperature
- $T_e$  Evaporating temperature
- █ Quick
- █ Powerful
- █ Mild



Room temperature evolution:

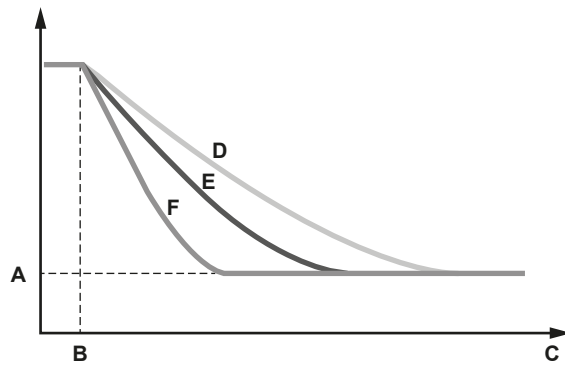

- A Indoor unit set temperature
- B Operation start
- C Operating time
- D Mild
- E Quick
- F Powerful

7.2.4 Example: Automatic mode during heating

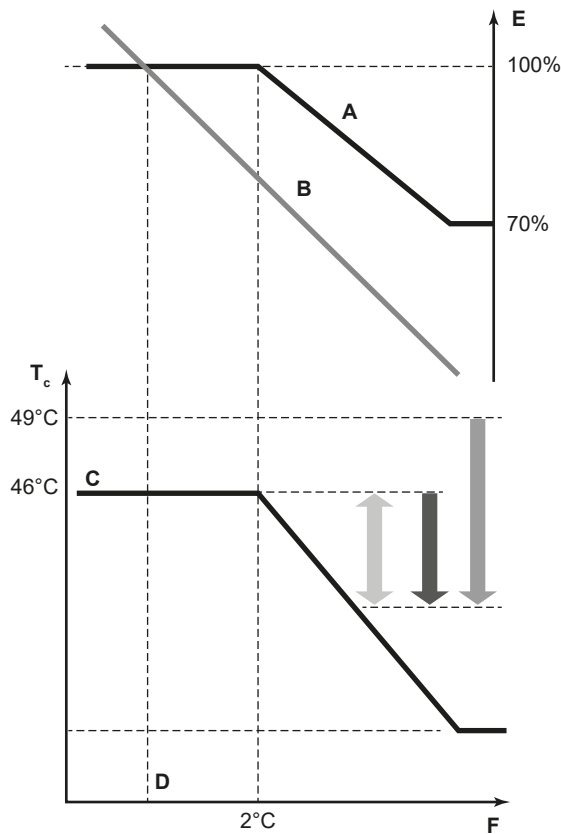

- A Virtual load curve (default automatic mode peak capacity)
- B Load curve
- C Virtual target value (initial condensation temperature value automatic mode)
- D Design temperature
- E Load factor
- F Outside air temperature
- $T_c$  Condensing temperature
- █ Quick
- █ Powerful
- █ Mild

Room temperature evolution:

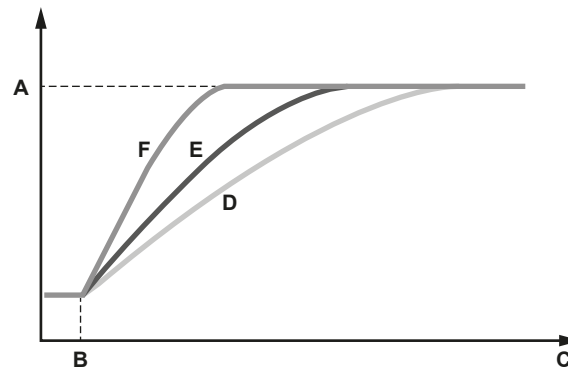

- A Indoor unit set temperature
- B Operation start
- C Operating time
- D Mild
- E Quick
- F Powerful

# 8 Commissioning

## In this chapter

8.1	Overview: Commissioning .....	91
8.2	Precautions when commissioning.....	91
8.3	Checklist before commissioning.....	92
8.4	Checklist during commissioning .....	93
8.4.1	About the system test run .....	93
8.4.2	To perform a test run (7-LEDs display) .....	94
8.4.3	To perform a test run (7-segment display).....	94
8.4.4	Correcting after abnormal completion of the test run .....	95

## 8.1 Overview: Commissioning

After installation and once the field settings are defined, the installer is obliged to verify correct operation. Therefore a test run **MUST** be performed according to the procedures described below.

This chapter describes what you have to do and know to commission the system after it is configured.

Commissioning typically consists of the following stages:

- 1 Checking the "Checklist before commissioning".
- 2 Performing a test run.
- 3 If necessary, correcting errors after abnormal completion of the test run.
- 4 Operating the system.

## 8.2 Precautions when commissioning



**DANGER: RISK OF ELECTROCUTION**



**DANGER: RISK OF BURNING/SCALDING**



**CAUTION**

**Do NOT perform the test operation while working on the indoor units.**

When performing the test operation, **NOT ONLY** the outdoor unit, but the connected indoor unit will operate as well. Working on an indoor unit while performing a test operation is dangerous.



**CAUTION**

**Do NOT** insert fingers, rods or other objects into the air inlet or outlet. **Do NOT** remove the fan guard. When the fan is rotating at high speed, it will cause injury.

**INFORMATION**

During the first running period of the unit, the required power may be higher than stated on the nameplate of the unit. This phenomenon is caused by the compressor, that needs a continuous run time of 50 hours before reaching smooth operation and stable power consumption.

**NOTICE**

Turn ON the power 6 hours before operation in order to have power running to the crankcase heater and to protect the compressor.

During test operation, the outdoor unit and the indoor units will start up. Make sure that the preparations of all indoor units are finished (field piping, electrical wiring, air purge, ...). See installation manual of the indoor units for details.

### 8.3 Checklist before commissioning

- 1 After the installation of the unit, check the items listed below.
- 2 Close the unit.
- 3 Power up the unit.

<input type="checkbox"/>	You have read the complete installation and operation instructions described in the <b>installer and user reference guide</b> .
<input type="checkbox"/>	<b>Installation</b> Check that the unit is properly installed, to avoid abnormal noises and vibrations when starting up the unit.
<input type="checkbox"/>	<b>Transportation stay</b> Check that the outdoor unit's transportation stay is removed.
<input type="checkbox"/>	<b>Field wiring</b> Be sure that the field wiring has been carried out according to the instructions described in the chapter " <a href="#">6.7 Connecting the electrical wiring</a> " [▶ 62], according to the wiring diagrams and according to the applicable legislation.
<input type="checkbox"/>	<b>Power supply voltage</b> Check the power supply voltage on the local supply panel. The voltage MUST correspond to the voltage on the nameplate of the unit.
<input type="checkbox"/>	<b>Earth wiring</b> Be sure that the earth wires have been connected properly and that the earth terminals are tightened.
<input type="checkbox"/>	<b>Insulation test of the main power circuit</b> Using a megatester for 500 V, check that the insulation resistance of 2 MΩ or more is attained by applying a voltage of 500 V DC between power terminals and earth. NEVER use the megatester for the interconnection wiring.
<input type="checkbox"/>	<b>Fuses, circuit breakers, or protection devices</b> Check that the fuses, circuit breakers, or the locally installed protection devices are of the size and type specified in the chapter " <a href="#">5.3.2 Safety device requirements</a> " [▶ 38]. Be sure that neither a fuse nor a protection device has been bypassed.
<input type="checkbox"/>	<b>Internal wiring</b> Visually check the switch box and the inside of the unit for loose connections or damaged electrical components.
<input type="checkbox"/>	<b>Pipe size and pipe insulation</b> Be sure that correct pipe sizes are installed and that the insulation work is properly executed.

<input type="checkbox"/>	<b>Stop valves</b> Be sure that the stop valves are open on both liquid and gas side.
<input type="checkbox"/>	<b>Damaged equipment</b> Check the inside of the unit for damaged components or squeezed pipes.
<input type="checkbox"/>	<b>Refrigerant leak</b> Check the inside of the unit on refrigerant leakage. If there is a refrigerant leak, try to repair the leak. If the repair is unsuccessful, call your local dealer. Do not touch any refrigerant which has leaked out from refrigerant piping connections. This may result in frostbite.
<input type="checkbox"/>	<b>Oil leak</b> Check the compressor for oil leakage. If there is an oil leak, try to repair the leak. If the repairing is unsuccessful, call your local dealer.
<input type="checkbox"/>	<b>Air inlet/outlet</b> Check that the air inlet and outlet of the unit is NOT obstructed by paper sheets, cardboard, or any other material.
<input type="checkbox"/>	<b>Additional refrigerant charge</b> The amount of refrigerant to be added to the unit shall be written on the included "Added refrigerant" plate and attached to the rear side of the front cover.
<input type="checkbox"/>	<b>Installation date and field setting</b> Be sure to keep a record of the installation date on the sticker on the rear of the front panel according to EN60335-2-40 and keep record of the contents of the field setting(s).

## 8.4 Checklist during commissioning

<input type="checkbox"/>	To perform a <b>test run</b> .
--------------------------	--------------------------------

### 8.4.1 About the system test run



#### NOTICE

Make sure to carry out the test run after the first installation. Otherwise, the malfunction code **U3** will be displayed on the user interface and normal operation or individual indoor unit test run cannot be carried out.

The procedure below describes the test operation of the complete system. This operation checks and judges following items:

- Check of wrong wiring (communication check with indoor units).
- Check of the stop valves opening.
- Judgement of piping length.

Abnormalities on indoor units cannot be checked for each unit separately. After the test operation is finished, check the indoor units one by one by performing a normal operation using the user interface. Refer to the indoor unit installation manual for more details concerning the individual test run.



#### INFORMATION

- It may take 10 minutes to achieve a uniform refrigerant state before the compressor starts.
- During the test operation, the refrigerant running sound or the magnetic sound of a solenoid valve may become loud and the display indication may change. These are not malfunctions.

8.4.2 To perform a test run (7-LEDs display)

Use this procedure in case of RXYSQ8.

- 1 Make sure all field settings you want are set; see ["7.1 Making field settings"](#) [▶ 71].
- 2 Turn ON the power to the outdoor unit and the connected indoor units.



**NOTICE**  
Turn ON the power 6 hours before operation in order to have power running to the crankcase heater and to protect the compressor.

- 3 Make sure the default (idle) situation is existing (H1P is OFF); see ["7.1.4 To access mode 1 or 2"](#) [▶ 74]. Push BS4 for 5 seconds or more. The unit will start test operation.

**Result:** The test operation is automatically carried out, the outdoor unit H2P flashes and the indication "Test operation" and "Under centralised control" will display on the user interface of indoor units.

Steps during the automatic system test run procedure:

Step	Description
● ✨ ● ● ● ● ✨	Control before start up (pressure equalisation)
● ✨ ● ● ● ✨ ●	Cooling start up control
● ✨ ● ● ● ✨ ✨	Cooling stable condition
● ✨ ● ● ✨ ● ●	Communication check
● ✨ ● ● ✨ ● ✨	Stop valve check
● ✨ ● ● ✨ ✨ ●	Pipe length check
● ✨ ● ✨ ● ● ✨	Pump down operation
● ✨ ● ✨ ● ✨ ●	Unit stop



**INFORMATION**  
During the test operation, it is not possible to stop the unit operation from a user interface. To abort the operation, press BS3. The unit will stop after ±30 seconds.

- 4 Check the test operation results on the outdoor unit 7-LEDs display.

Completion	Description
Normal completion	● ● ✨ ● ● ● ●
Abnormal completion	● ✨ ✨ ● ● ● ● Refer to <a href="#">"8.4.4 Correcting after abnormal completion of the test run"</a> [▶ 95] to take actions for correcting the abnormality. When the test operation is fully completed, normal operation will be possible after 5 minutes.

8.4.3 To perform a test run (7-segment display)

Use this procedure in case of RXYSQ10+12.

- 1 Make sure all field settings you want are set; see ["7.1 Making field settings"](#) [▶ 71].

- 2 Turn ON the power to the outdoor unit and the connected indoor units.

**NOTICE**

Turn ON the power 6 hours before operation in order to have power running to the crankcase heater and to protect the compressor.

- 3 Make sure the default (idle) situation is existing; see "[7.1.4 To access mode 1 or 2](#)" [▶ 74]. Push BS2 for 5 seconds or more. The unit will start test operation.

**Result:** The test operation is automatically carried out, the outdoor unit display will indicate "E01" and the indication "Test operation" and "Under centralised control" will display on the user interface of indoor units.

Steps during the automatic system test run procedure:

Step	Description
E01	Control before start up (pressure equalisation)
E02	Cooling start up control
E03	Cooling stable condition
E04	Communication check
E05	Stop valve check
E06	Pipe length check
E09	Pump down operation
E10	Unit stop

**INFORMATION**

During the test operation, it is not possible to stop the unit operation from a user interface. To abort the operation, press BS3. The unit will stop after ±30 seconds.

- 4 Check the test operation results on the outdoor unit 7-segment display.

Completion	Description
Normal completion	No indication on the 7-segment display (idle).
Abnormal completion	Indication of malfunction code on the 7-segment display. Refer to " <a href="#">8.4.4 Correcting after abnormal completion of the test run</a> " [▶ 95] to take actions for correcting the abnormality. When the test operation is fully completed, normal operation will be possible after 5 minutes.

#### 8.4.4 Correcting after abnormal completion of the test run

The test operation is only completed if there is no malfunction code displayed. In case of a displayed malfunction code, perform correcting actions as explained in the malfunction code table. Carry out the test operation again and confirm that the abnormality is properly corrected.



### INFORMATION

If a malfunction occurs:

- In case of RXYSQ8: The error code is displayed on the user interface of the indoor unit.
- In case of RXYSQ10+12: The error code is displayed on the outdoor unit's 7-segments display and on the user interface of the indoor unit.



### INFORMATION

Refer to the installation manual of the indoor unit for detailed malfunction codes related to indoor units.





## 9 Hand-over to the user

Once the test run is finished and the unit operates properly, make sure the following is clear for the user:

- Make sure that the user has the printed documentation and ask him/her to keep it for future reference. Inform the user that he can find the complete documentation at the URL mentioned earlier in this manual.
- Explain the user how to properly operate the system and what to do in case of problems.
- Show the user what to do for the maintenance of the unit.

# 10 Maintenance and service

 **NOTICE**  
 Maintenance **MUST** be done by an authorised installer or service agent.  
 We recommend performing maintenance at least once a year. However, applicable legislation might require shorter maintenance intervals.

 **NOTICE**  
 Applicable legislation on **fluorinated greenhouse gases** requires that the refrigerant charge of the unit is indicated both in weight and CO<sub>2</sub> equivalent.  
**Formula to calculate the quantity in CO<sub>2</sub> equivalent tonnes:** GWP value of the refrigerant × total refrigerant charge [in kg] / 1000

## In this chapter

10.1	Maintenance safety precautions.....	98
10.1.1	To prevent electrical hazards.....	98
10.2	Checklist for yearly maintenance of the outdoor unit.....	99
10.3	About service mode operation.....	99
10.3.1	To use vacuum mode.....	99
10.3.2	To recover refrigerant.....	100

## 10.1 Maintenance safety precautions

 **DANGER: RISK OF ELECTROCUTION**

 **DANGER: RISK OF BURNING/SCALDING**

 **NOTICE: Risk of electrostatic discharge**  
 Before performing any maintenance or service work, touch a metal part of the unit in order to eliminate static electricity and to protect the PCB.

### 10.1.1 To prevent electrical hazards

When performing service to inverter equipment:

- 1 Do NOT perform electrical work for 10 minutes after turning off the power supply.
- 2 Measure the voltage between terminals on the terminal block for power supply with a tester and confirm that the power supply is shut off. In addition, measure points as shown in the figure, with a tester and confirm that the voltage of the capacitor in the main circuit is less than 50 V DC. If the voltage measured is still higher than 50 V DC, discharge the capacitors in a safe manner by using a dedicated capacitor discharge pen to avoid possibility of sparking.

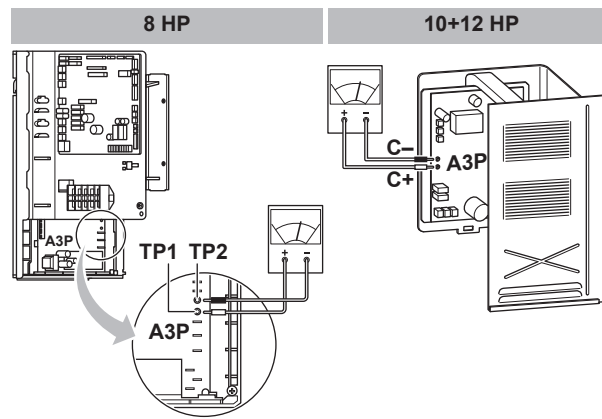

- 3 To prevent damaging the PCB, touch a non-coated metal part to eliminate static electricity before pulling out or plugging in connectors.
- 4 Pull out junction connectors for the fan motors in the outdoor unit before starting service operation on the inverter equipment. Be careful NOT to touch the live parts. (If a fan rotates due to strong wind, it may store electricity in the capacitor or in the main circuit and cause electrical shock.)

Junction connectors	X1A, X2A for M1F X3A, X4A for M2F
---------------------	--------------------------------------

- 5 After the service is finished, plug the junction connector back in. Otherwise the malfunction code E7 will be displayed and normal operation will NOT be performed.

For details refer to the wiring diagram labelled on the back of the service cover.

Pay attention to the fan. It is dangerous to inspect the unit while the fan is running. Make sure to turn off the main switch and to remove the fuses from the control circuit located in the outdoor unit.

## 10.2 Checklist for yearly maintenance of the outdoor unit

Check the following at least once a year:

- Heat exchanger

The heat exchanger of the outdoor unit can get blocked up due to dust, dirt, leaves, etc. It is recommended to clean the heat exchanger yearly. A blocked heat exchanger can lead to too low pressure or too high pressure leading to worse performance.



## 10.3 About service mode operation

Refrigerant recovery operation/vacuuming operation is possible by applying setting [2-21]. Refer to "[7.1 Making field settings](#)" [▶ 71] for details how to set mode 2.

When vacuuming/recovery mode is used, check very carefully what should be vacuumed/recovered before starting. See installation manual of the indoor unit for more information about vacuuming and recovery.

### 10.3.1 To use vacuum mode

- 1 When the unit is at standstill, activate setting [2-21] to start vacuuming mode.

Model	Result
RXYSQ8	When confirmed, the indoor and outdoor unit expansion valves will fully open. At that moment H1P lights and the user interface of all indoor units indicate TEST (test operation) and  (external control) and the operation will be prohibited.
RXYSQ10+12	When confirmed, the indoor and outdoor unit expansion valves will fully open. At that moment the 7-segment display indication= $\text{E} \square \text{I}$ and the user interface of all indoor units indicate TEST (test operation) and  (external control) and the operation will be prohibited.

- 2 Evacuate the system with a vacuum pump.
- 3 Press BS1 (in case of RXYSQ8) or BS3 (in case of RXYSQ10+12) to stop vacuuming mode.

### 10.3.2 To recover refrigerant

This should be done with a refrigerant recovery unit. Follow the same procedure as for vacuuming method.



#### **DANGER: RISK OF EXPLOSION**

**Pump down – Refrigerant leakage.** If you want to pump down the system, and there is a leak in the refrigerant circuit:

- Do NOT use the unit's automatic pump down function, with which you can collect all refrigerant from the system into the outdoor unit. **Possible consequence:** Self-combustion and explosion of the compressor because of air going into the operating compressor.
- Use a separate recovery system so that the unit's compressor does NOT have to operate.



#### **NOTICE**

Make sure to NOT recover any oil while recovering refrigerant. **Example:** By using an oil separator.

# 11 Troubleshooting

In this chapter

11.1	Overview: Troubleshooting .....	101
11.2	Precautions when troubleshooting .....	101
11.3	Solving problems based on error codes .....	101
11.3.1	Error codes: Overview .....	102

## 11.1 Overview: Troubleshooting

### Before troubleshooting

Carry out a thorough visual inspection of the unit and look for obvious defects such as loose connections or defective wiring.

## 11.2 Precautions when troubleshooting



### DANGER: RISK OF ELECTROCUTION



### DANGER: RISK OF BURNING/SCALDING



### WARNING

- When carrying out an inspection on the switch box of the unit, ALWAYS make sure that the unit is disconnected from the mains. Turn off the respective circuit breaker.
- When a safety device was activated, stop the unit and find out why the safety device was activated before resetting it. NEVER shunt safety devices or change their values to a value other than the factory default setting. If you are unable to find the cause of the problem, call your dealer.



### WARNING

Prevent hazards due to inadvertent resetting of the thermal cut-out: power to this appliance MUST NOT be supplied through an external switching device, such as a timer, or connected to a circuit that is regularly turned ON and OFF by the utility.

## 11.3 Solving problems based on error codes

In case of a displayed malfunction code, perform correcting actions as explained in the malfunction code table.

After correcting the abnormality, press BS3 to reset the malfunction code and retry operation.



**INFORMATION**

If a malfunction occurs:



- In case of RXYSQ8: The error code is displayed on the user interface of the indoor unit.
- In case of RXYSQ10+12: The error code is displayed on the outdoor unit's 7-segments display and on the user interface of the indoor unit.



**INFORMATION**

If a malfunction occurs, the error code is displayed on the outdoor unit's 7-segments display and on the user interface of the indoor unit.

In case of RXYSQ10+12: The error code on the outdoor unit will indicate a main malfunction code and a sub code. The sub code indicates more detailed information about the malfunction code. The main code and sub code will be displayed intermittent (with an interval of 1 second). **Example:**

- Main code: 
- Sub code: 

11.3.1 Error codes: Overview

**In case of RXYSQ8:**

Main code	Cause	Solution
E3	<ul style="list-style-type: none"> <li>▪ The stop valve of an outdoor unit is left closed.</li> <li>▪ Refrigerant overcharge</li> </ul>	<ul style="list-style-type: none"> <li>▪ Open the stop valve on both the gas and liquid side.</li> <li>▪ Recalculate the required amount of refrigerant from the piping length and correct the refrigerant charge level by recovering any excessive refrigerant with a refrigerant recovery machine.</li> </ul>
E4	<ul style="list-style-type: none"> <li>▪ The stop valve of an outdoor unit is left closed.</li> <li>▪ Insufficient refrigerant</li> </ul>	<ul style="list-style-type: none"> <li>▪ Open the stop valve on both the gas and liquid side.</li> <li>▪ Check if the additional refrigerant charge has been finished correctly. Recalculate the required amount of refrigerant from the piping length and add an adequate amount of refrigerant.</li> </ul>
E9	Electronic expansion valve malfunction (Y1E) - A1P (X21A) (Y2E) - A1P (X23A)	Check connection on PCB or actuator.
F3	<ul style="list-style-type: none"> <li>▪ The stop valve of an outdoor unit is left closed.</li> <li>▪ Insufficient refrigerant</li> </ul>	<ul style="list-style-type: none"> <li>▪ Open the stop valve on both the gas and liquid side.</li> <li>▪ Check if the additional refrigerant charge has been finished correctly. Recalculate the required amount of refrigerant from the piping length and add an adequate amount of refrigerant.</li> </ul>

Main code	Cause	Solution
F5	Refrigerant overcharge	Recalculate the required amount of refrigerant from the piping length and correct the refrigerant charge level by recovering any excessive refrigerant with a refrigerant recovery machine.
H9	Ambient temperature sensor malfunction (R1T) - A1P (X18A)	Check connection on PCB or actuator.
J3	Discharge temperature sensor malfunction (R3T): open circuit / short circuit - A1P (X29A)	Check connection on PCB or actuator.
J5	Suction temperature sensor malfunction (R2T) - A1P (X30A) (R7T) - A1P (X30A)	Check connection on PCB or actuator.
J7	Liquid temperature sensor (after subcool HE) malfunction (R6T) - A1P (X30A)	Check connection on PCB or actuator.
J8	Liquid temperature sensor (coil) malfunction (R4T) - A1P (X30A)	Check connection on PCB or actuator.
J9	Gas temperature sensor (after subcool HE) malfunction (R5T) - A1P (X30A)	Check connection on PCB or actuator.
JA	High pressure sensor malfunction (S1NPH): open circuit / short circuit - A1P (X32A)	Check connection on PCB or actuator.
JC	Low pressure sensor malfunction (S1NPL): open circuit / short circuit - A1P (X31A)	Check connection on PCB or actuator.
LC	Transmission outdoor unit - inverter: INV1 / FAN1 / FAN2 transmission trouble - A1P (X20A, X28A)	Check connection.
P1	INV1 unbalanced power supply voltage	Check if power supply is within range.
U1	Reversed power supply phase malfunction	Correct phase order.
U2	Insufficient supply voltage	Check if the supply voltage is supplied properly.
U3	Malfunction code: System test run not yet executed (system operation not possible)	Execute system test run.
U4	No power is supplied to the outdoor unit.	Check if the power wiring for the outdoor unit is connected correctly.
U7	Faulty wiring to Q1/Q2	Check Q1/Q2 wiring.
U9	System mismatch. Wrong type of indoor units combined (R410A, R407C, RA, etc) Indoor unit malfunction	Check if other indoor units have malfunction and confirm indoor unit mix is allowed.
UR	Improper type of indoor units are connected.	Check the type of indoor units that are currently connected. If they are not proper, replace them with proper ones.
UH	Incorrect interconnections between units.	Connect interconnections F1 and F2 of the connected BP unit correctly to the outdoor unit's PCB (TO BP UNIT). Make sure that the communication with the BP unit is enabled.

Main code	Cause	Solution
UF	<ul style="list-style-type: none"> <li>The stop valve of an outdoor unit is left closed.</li> <li>The piping and wiring of the specified indoor unit are not connected correctly to the outdoor unit.</li> </ul>	<ul style="list-style-type: none"> <li>Open the stop valve on both the gas and liquid side.</li> <li>Confirm that the piping and wiring of the specified indoor unit are connected correctly to the outdoor unit.</li> </ul>

**In case of RXYSQ10+12:**

Main code	Sub code	Cause	Solution
E2	-05	Earth leakage detector activated	Restart the unit. If problem reoccurs, contact your dealer.
E3	-01	High pressure switch was activated (S1PH) - A1P (X4A)	Check stop valve situation or abnormalities in (field) piping or airflow over air cooled coil.
	-02	<ul style="list-style-type: none"> <li>Refrigerant overcharge</li> <li>Stop valve closed</li> </ul>	<ul style="list-style-type: none"> <li>Check refrigerant amount+recharge unit.</li> <li>Open stop valves</li> </ul>
	-13	Stop valve closed (liquid)	Open liquid stop valve.
	-18	<ul style="list-style-type: none"> <li>Refrigerant overcharge</li> <li>Stop valve closed</li> </ul>	<ul style="list-style-type: none"> <li>Check refrigerant amount+recharge unit.</li> <li>Open stop valves.</li> </ul>
E4	-01	Low pressure malfunction: <ul style="list-style-type: none"> <li>Stop valve closed</li> <li>Refrigerant shortage</li> <li>Indoor unit malfunction</li> </ul>	<ul style="list-style-type: none"> <li>Open stop valves.</li> <li>Check refrigerant amount+recharge unit.</li> <li>Check the user interface's display or transmission wiring between the outdoor unit and the indoor unit.</li> </ul>
E9	-01	Electronic expansion valve malfunction (subcool) (Y2E) - A1P (X21A)	Check connection on PCB or actuator.
	-04	Electronic expansion valve malfunction (main) (Y1E) - A1P (X23A)	Check connection on PCB or actuator.
F3	-01	Discharge temperature too high (R21T): <ul style="list-style-type: none"> <li>Stop valve closed</li> <li>Refrigerant shortage</li> </ul>	<ul style="list-style-type: none"> <li>Open stop valves.</li> <li>Check refrigerant amount+recharge unit.</li> </ul>
	-20	Compressor casing temperature too high (R8T): <ul style="list-style-type: none"> <li>Stop valve closed</li> <li>Refrigerant shortage</li> </ul>	<ul style="list-style-type: none"> <li>Open stop valves.</li> <li>Check refrigerant amount+recharge unit.</li> </ul>
F5	-02	<ul style="list-style-type: none"> <li>Refrigerant overcharge</li> <li>Stop valve closed</li> </ul>	<ul style="list-style-type: none"> <li>Check refrigerant amount+recharge unit.</li> <li>Open stop valves.</li> </ul>
H9	-01	Ambient temperature sensor malfunction (R1T) - A1P (X18A)	Check connection on PCB or actuator.



Main code	Sub code	Cause	Solution
J3	-15	Discharge temperature sensor malfunction (R21T): open circuit - A1P (X29A)	Check connection on PCB or actuator.
	-17	Discharge temperature sensor malfunction (R21T): short circuit - A1P (X29A)	Check connection on PCB or actuator.
	-47	Compressor casing temperature sensor malfunction (R8T): open circuit - A1P (X29A)	Check connection on PCB or actuator.
	-48	Compressor casing temperature sensor malfunction (R8T): short circuit - A1P (X29A)	Check connection on PCB or actuator.
J5	-01	Suction temperature sensor malfunction (R3T) - A1P (X30A)	Check connection on PCB or actuator.
J6	-01	De-icing temperature sensor malfunction (R7T) - A1P (X30A)	Check connection on PCB or actuator
J7	-05	Liquid temperature sensor (after subcool HE) malfunction (R5T) - A1P (X30A)	Check connection on PCB or actuator.
J8	-01	Liquid temperature sensor (coil) malfunction (R4T) - A1P (X30A)	Check connection on PCB or actuator.
J9	-01	Gas temperature sensor (after subcool HE) malfunction (R6T) - A1P (X30A)	Check connection on PCB or actuator.
JA	-05	High pressure sensor malfunction (S1NPH): open circuit - A1P (X32A)	Check connection on PCB or actuator.
	-07	High pressure sensor malfunction (S1NPH): short circuit - A1P (X32A)	Check connection on PCB or actuator.
JC	-05	Low pressure sensor malfunction (S1NPL): open circuit - A1P (X31A)	Check connection on PCB or actuator.
	-07	Low pressure sensor malfunction (S1NPL): short circuit - A1P (X31A)	Check connection on PCB or actuator.
LE	-14	Transmission outdoor unit - inverter: INV1 transmission trouble - A1P (X20A, X28A, X42A)	Check connection.
	-19	Transmission outdoor unit - inverter: FAN1 transmission trouble - A1P (X20A, X28A, X42A)	Check connection.
	-24	Transmission outdoor unit - inverter: FAN2 transmission trouble - A1P (X20A, X28A, X42A)	Check connection.
P1	-01	INV1 unbalanced power supply voltage	Check if power supply is within range.
U1	-01	Reversed power supply phase malfunction	Correct phase order.
	-04	Reversed power supply phase malfunction	Correct phase order.

Main code	Sub code	Cause	Solution
U2	-01	INV1 voltage power shortage	Check if power supply is within range.
	-02	INV1 power phase loss	Check if power supply is within range.
U3	-03	Malfunction code: System test run not yet executed (system operation not possible)	Execute system test run.
U4	-01	Faulty wiring to Q1/Q2 or indoor - outdoor	Check (Q1/Q2) wiring.
	-03	Faulty wiring to Q1/Q2 or indoor - outdoor	Check (Q1/Q2) wiring.
	-04	System test run abnormal ending	Execute test run again.
U7	-01	Warning: faulty wiring to Q1/Q2	Check Q1/Q2 wiring.
	-02	Malfunction code: faulty wiring to Q1/Q2	Check Q1/Q2 wiring.
	-11	<ul style="list-style-type: none"> <li>▪ Too many indoor units are connected to F1/F2 line</li> <li>▪ Bad wiring between outdoor and indoor units</li> </ul>	Check indoor unit amount and total capacity connected.
U9	-01	System mismatch. Wrong type of indoor units combined (R410A, R407C, RA, etc) Indoor unit malfunction	Check if other indoor units have malfunction and confirm indoor unit mix is allowed.
UR	-03	Connection malfunction over indoor units or type mismatch (R410A, R407C, RA, etc)	Check if other indoor units have malfunction and confirm indoor unit mix is allowed.
	-18	Connection malfunction over indoor units or type mismatch (R410A, R407C, RA, etc)	Check if other indoor units have malfunction and confirm indoor unit mix is allowed.
UH	-01	Auto address malfunction (inconsistency)	Check if transmission wired unit amount matches with powered unit amount (by monitor mode) or wait till initialisation is finished.
UF	-01	Auto address malfunction (inconsistency)	Check if transmission wired unit amount matches with powered unit amount (by monitor mode) or wait till initialisation is finished.
	-05	Stop valve closed or wrong (during system test run)	Open stop valves.

# 12 Disposal

**NOTICE**

Do NOT try to dismantle the system yourself: dismantling of the system, treatment of the refrigerant, oil and other parts **MUST** comply with applicable legislation. Units **MUST** be treated at a specialised treatment facility for reuse, recycling and recovery.

# 13 Technical data

A **subset** of the latest technical data is available on the regional Daikin website (publicly accessible). The **full set** of the latest technical data is available on the Daikin Business Portal (authentication required).

## In this chapter

13.1	Service space: Outdoor unit .....	109
13.2	Piping diagram: Outdoor unit.....	111
13.3	Wiring diagram: Outdoor unit.....	113

### 13.1 Service space: Outdoor unit

In case of RXYSQ8:

- When mounting units side by side, the piping route must be to the front, to the back or downwards. In this case the piping route to the side is not possible.
- When mounting the units side by side and routing the piping to the back, you must keep a distance of  $\geq 250$  mm between the units (instead of  $\geq 100$  mm as shown on the figures below).

In case of RXYSQ10+12: When mounting units side by side, the piping route must be to the front or downwards. In this case the piping route to the side is not possible.

Single unit (  ) | Single row of units (  )

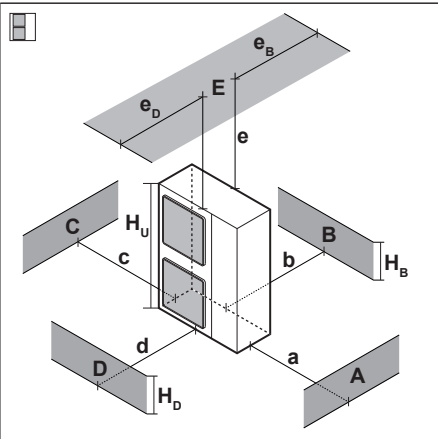
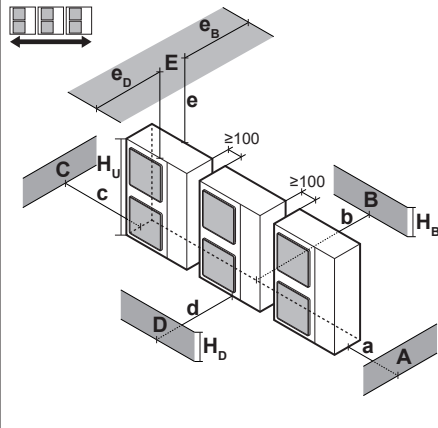
	A~E	$H_B$ $H_D$ $H_U$		[mm]							
				a	b	c	d	e		$e_B$	$e_D$
	B	—			$\geq 100$						
	A, B, C	—		$\geq 100$	$\geq 100$	$\geq 100$					
	B, E	—			$\geq 100$			$\geq 1000$		$\leq 500$	
	A, B, C, E	—		$\geq 150$	$\geq 150$	$\geq 150$		$\geq 1000$		$\leq 500$	
	D	—					$\geq 500$				
	D, E	—					$\geq 1000$	$\geq 1000$		$\leq 500$	
	B, D	—			$\geq 100$		$\geq 1000$				
	B, D, E	$H_B < H_D$	$H_B \leq \frac{1}{2}H_U$		$\geq 250$		$\geq 1000$	$\geq 1000$		$\leq 500$	1
			$\frac{1}{2}H_U < H_B \leq H_U$		$\geq 250$		$\geq 1250$	$\geq 1000$	$\leq 500$		
			$H_B > H_U$	⊘							
$H_B > H_D$	$H_B \leq \frac{1}{2}H_U$		$\geq 100$		$\geq 1000$	$\geq 1000$		$\leq 500$	1		
	$\frac{1}{2}H_U < H_B \leq H_U$		$\geq 200$		$\geq 1000$	$\geq 1000$	$\leq 500$				
	$H_D > H_U$		$\geq 200$		$\geq 1700$	$\geq 1000$	$\leq 500$				
	A, B, C	—		$\geq 200$	$\geq 300$	$\geq 1000$					
	A, B, C, E	—		$\geq 200$	$\geq 300$	$\geq 1000$		$\geq 1000$		$\leq 500$	
	D	—					$\geq 1000$				
	D, E	—					$\geq 1000$	$\geq 1000$	$\leq 500$		
	B, D	$H_D > H_U$			$\geq 300$		$\geq 1000$				
			$H_D \leq \frac{1}{2}H_U$		$\geq 250$		$\geq 1500$				
			$\frac{1}{2}H_U < H_D \leq H_U$		$\geq 300$		$\geq 1500$				
	B, D, E	$H_B < H_D$	$H_B \leq \frac{1}{2}H_U$		$\geq 300$		$\geq 1000$	$\geq 1000$		$\leq 500$	1+2
			$\frac{1}{2}H_U < H_B \leq H_U$		$\geq 300$		$\geq 1250$	$\geq 1000$	$\leq 500$		
			$H_B > H_U$	⊘							
$H_B > H_D$		$H_D \leq \frac{1}{2}H_U$		$\geq 250$		$\geq 1500$	$\geq 1000$	$\leq 500$			
$H_D > H_U$	$\frac{1}{2}H_U < H_D \leq H_U$		$\geq 300$		$\geq 1500$	$\geq 1000$	$\leq 500$				
	$H_D > H_U$		$\geq 300$		$\geq 2200$	$\geq 1000$	$\leq 500$				

- A,B,C,D** Obstacles (walls/baffle plates)
- E** Obstacle (roof)
- a,b,c,d,e** Minimum service space between the unit and obstacles A, B, C, D and E
- $e_B$**  Maximum distance between the unit and the edge of obstacle E, in the direction of obstacle B
- $e_D$**  Maximum distance between the unit and the edge of obstacle E, in the direction of obstacle D
- $H_U$**  Height of the unit
- $H_B, H_D$**  Height of obstacles B and D
- 1** Seal the bottom of the installation frame to prevent discharged air from flowing back to the suction side through the bottom of the unit.
- 2** Maximum two units can be installed.
- ⊘** Not allowed





**RXYSQ10+12**

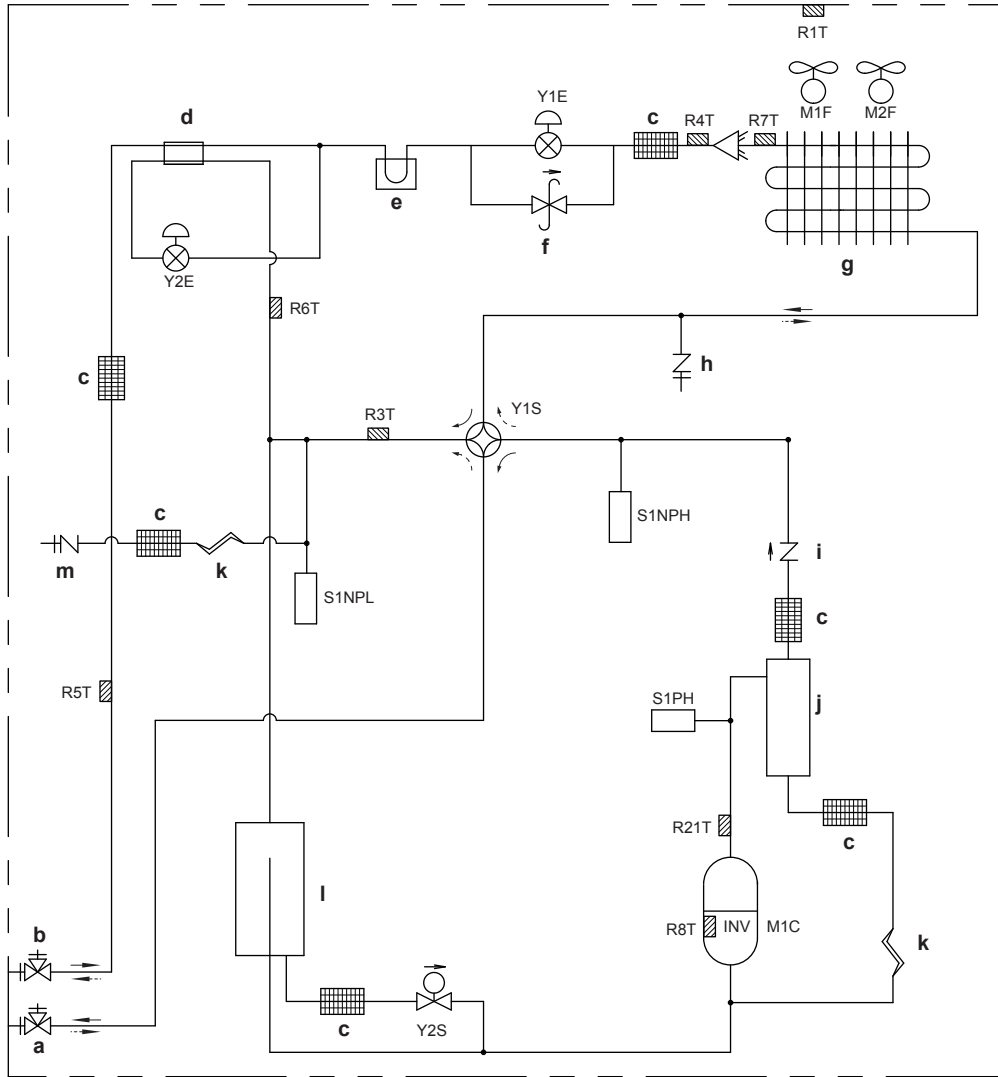

- |  |  |
|--|--|
| <b>a</b> Stop valve (gas)                  | <b>R21T</b> Thermistor (discharge)                             |
| <b>b</b> Stop valve (liquid)               | <b>R3T</b> Thermistor (suction)                                |
| <b>c</b> Filter (6x)                       | <b>R4T</b> Thermistor (heat exchanger liquid pipe)             |
| <b>d</b> Subcool heat exchanger            | <b>R5T</b> Thermistor (liquid pipe)                            |
| <b>e</b> Heat sink PCB                     | <b>R6T</b> Thermistor (subcool heat exchanger)                 |
| <b>f</b> Pressure regulating valve         | <b>R7T</b> Thermistor (heat exchanger de-icer)                 |
| <b>g</b> Heat exchanger                    | <b>R8T</b> Thermistor (M1C body)                               |
| <b>h</b> Service port (high pressure)      | <b>S1NPH</b> High pressure sensor                              |
| <b>i</b> Check valve                       | <b>S1NPL</b> Low pressure sensor                               |
| <b>j</b> Oil separator                     | <b>S1PH</b> High pressure switch                               |
| <b>k</b> Capillary tube (2x)               | <b>Y1E</b> Electronic expansion valve (main)                   |
| <b>I</b> Accumulator                       | <b>Y2E</b> Electronic expansion valve (subcool heat exchanger) |
| <b>m</b> Service port (refrigerant charge) | <b>Y1S</b> Solenoid valve (4-way valve)                        |
| <b>M1C</b> Compressor                      | <b>Y2S</b> Solenoid valve                                      |
| <b>M1F-M2F</b> Fan motor                   | ➔ Heating  |
| <b>R1T</b> Thermistor (air)                | ➔➔ Cooling   |



## 13.3 Wiring diagram: Outdoor unit

The wiring diagram is delivered with the unit, located at the inside of the service cover.

### Notes for RXYSQ8:

- 1 This wiring diagram applies only to the outdoor unit.
- 2 Symbols (see below).
- 3 Symbols (see below).
- 4 Refer to the installation manual for connection wiring to INDOOR-OUTDOOR transmission F1-F2 and OUTDOOR-OUTDOOR transmission F1-F2.
- 5 Refer to the installation manual for how to use the BS1~BS5 and DS1 switches.
- 6 When operating, do not short-circuit protective device S1PH.
- 7 Colours (see below).

### Notes for RXYSQ10+12:

- 1 This wiring diagram applies only to the outdoor unit.
- 2 Symbols (see below).
- 3 Refer to the installation manual for connection wiring to INDOOR-OUTDOOR transmission F1-F2 and OUTDOOR-OUTDOOR transmission F1-F2.
- 4 Refer to the installation manual for how to use the BS1~BS3 switches.
- 5 When operating, do not short-circuit protective device S1PH.
- 6 Colours (see below).

### Symbols:

L	Live
N	Neutral
⋮ ■ ■ ■ ⋮	Field wiring
□ □ □ □	Terminal strip
⊞	Connector
⊞	Fixed connector
⊞	Movable connector
⊞	Protective earth (screw)
⊞	Noiseless earth
⊞	Terminal

### Colours:

BLK	Black
BLU	Blue
BRN	Brown

GRN	Green
ORG	Orange
RED	Red
WHT	White
YLW	Yellow

#### Legend for wiring diagram RXYSQ8:

A1P	Printed circuit board (main)
A2P	Printed circuit board (noise filter)
A3P	Printed circuit board (inverter)
A4P	Printed circuit board (fan 1)
A5P	Printed circuit board (fan 2)
BS1~BS5	Push button switch
C32, C67	Capacitor
DS1	DIP switch
E1HC	Crankcase heater
F1U, F2U	Fuse (T 3.15 A / 250 V) (A1P)
F101U	Fuse (5 A, DC650 V) (A4P) (A5P)
F400U	Fuse (T 6.3 A / 250 V) (A2P)
H1P~H8P	Light-emitting diode (service monitor orange)
	H2P:
	<ul style="list-style-type: none"> <li>▪ Prepare, test: Flickering</li> <li>▪ Malfunction detection: Light up</li> </ul>
HAP	Light-emitting diode (service monitor is green)
K1R	Magnetic relay (A3P)
K2M	Magnetic contactor (M1C) (A3P)
K3R	Magnetic relay (A2P)
K3R	Magnetic relay (Y1S)
K5R	Magnetic relay (Y3S)
K7R	Magnetic relay (E1HC)
L1R	Reactor
M1C	Motor (compressor)
M1F, M2F	Motor (upper and lower fan)
PS	Switching power supply (A1P) (A3P)
Q1RP	Reverse phase protector
R2, R3	Resistor
R24	Resistor (current sensor) (A4P) (A5P)
R95	Resistor (current limiting)
R1T	Thermistor (air)

R2T	Thermistor (suction 1)
R3T	Thermistor (discharge)
R4T	Thermistor (heat exchanger de-icer)
R5T	Thermistor (subcool heat exchanger)
R6T	Thermistor (liquid pipe)
R7T	Thermistor (suction 2)
S1NPH	High pressure sensor
S1NPL	Low pressure sensor
S1PH	High pressure switch
V1CP	Safety devices input
V1R	IGBT module (A4P) (A5P)
V1R	Diode bridge IGBT module (A3P)
X1A, X2A	Connector (M1F)
X3A, X4A	Connector (M2F)
X1M	Terminal strip (power supply)
X1M	Terminal strip (control) (A1P)
Y1E	Electronic expansion valve (main)
Y2E	Electronic expansion valve (subcool heat exchanger)
Y1S	Solenoid valve
Y3S	Solenoid valve (4-way valve)
Z1C~Z8C	Noise filter (ferrite core)
Z1F	Noise filter (with surge absorber)

#### Legend for wiring diagram RXYSQ10+12:

A1P	Printed circuit board (main)
A2P	Printed circuit board (noise filter)
A3P	Printed circuit board (inverter)
A4P	Printed circuit board (fan 1)
A5P	Printed circuit board (fan 2)
BS1~BS3	Push button switch (A1P)
C47, C48	Capacitor
DS1, DS2	DIP switch (A1P)
E1HC	Crankcase heater
F1U, F2U	Fuse (T 3.15 A / 250 V) (A1P)
F101U	Fuse (A4P) (A5P)
F411U, F412U	Fuse (A2P)
F601U	Fuse (A3P)
HAP	Light-emitting diode (service monitor is green) (A1P) (A3P) (A4P) (A5P)

K1M	Magnetic contactor (A3P)
K1R	Magnetic relay (A3P)
K3R	Magnetic relay (A3P)
K4R	Magnetic relay (Y2S) (A1P)
K7R	Magnetic relay (E1HC) (A1P)
K11R	Magnetic relay (Y1S) (A1P)
L1R	Reactor
M1C	Motor (compressor)
M1F, M2F	Motor (upper and lower fan)
PS	Switching power supply (A1P) (A3P)
Q1LD	Leakage detection circuit (A1P)
Q1RP	Phase reversal detect circuit (A1P)
R1T	Thermistor (air)
R21T	Thermistor (discharge)
R3T	Thermistor (suction)
R4T	Thermistor (heat exchanger liquid pipe)
R5T	Thermistor (liquid pipe)
R6T	Thermistor (subcool heat exchanger)
R7T	Thermistor (heat exchanger de-icer)
R8T	Thermistor (M1C body)
R1	Resistor (current limiting) (A3P)
R24	Resistor (current sensor) (A4P)
R313	Resistor (current sensor) (A3P)
R865, R867	Resistor (A3P)
S1NPH	High pressure sensor
S1NPL	Low pressure sensor
S1PH	High pressure switch
SEG1~SEG3	7-segment display (A1P)
T1A	Current sensor
V1R	Power module (A3P) (A4P) (A5P)
V2R	Power module (A3P)
X1A, X2A	Connector (M1F)
X3A, X4A	Connector (M2F)
X1M	Terminal strip (power supply)
X1M	Terminal strip (control) (A1P)
Y1E	Electronic expansion valve (main)
Y2E	Electronic expansion valve (subcool heat exchanger)
Y1S	Solenoid valve (4-way valve)

---

Y2S	Solenoid valve
Z1C~Z4C	Noise filter (ferrite core)
Z1F	Noise filter (with surge absorber) (A2P)

For the user

# 14 About the system

The indoor unit part of this VRV IV-S heat pump system can be used for heating/cooling applications. The type of indoor unit which can be used depends on the outdoor units series.

In general following type of indoor units can be connected to a VRV IV-S heat pump system (not exhaustive list, depending on outdoor unit model and indoor unit model combinations):

- VRV direct expansion indoor units (air to air applications).
- RA direct expansion indoor units (air to air applications).
- AHU (air to air applications): EKEXV(A)-kit is required.
- Air curtain (air to air applications): See the combination table in the databook for more information.

AHU unit connection in pair to VRV IV-S heat pump outdoor unit is supported.

AHU unit connection in multi to VRV IV-S heat pump outdoor unit is supported, even combined with VRV IV-S direct expansion indoor unit(s).

For more specifications, see technical engineering data.



## WARNING

- Do NOT modify, disassemble, remove, reinstall or repair the unit yourself as incorrect dismantling or installation may cause an electrical shock or fire. Contact your dealer.
- In case of accidental refrigerant leaks, make sure there are no naked flames. The refrigerant itself is entirely safe, non-toxic and non-combustible, but it will generate toxic gas when it accidentally leaks into a room where combustion air from fan heaters, gas cookers, etc. is present. ALWAYS have qualified service personnel confirm that the point of leakage has been repaired or corrected before resuming operation.



## NOTICE

Do NOT use the system for other purposes. In order to avoid any quality deterioration, do NOT use the unit for cooling precision instruments, food, plants, animals, or works of art.



## NOTICE

For future modifications or expansions of your system:

A full overview of allowable combinations (for future system extensions) is available in technical engineering data and should be consulted. Contact your installer to receive more information and professional advice.



## INFORMATION

- Combination of VRV DX and RA DX indoor units is not allowed.
- Combination of RA DX and AHU indoor units is not allowed.
- Combination of RA DX and air curtain indoor units is not allowed.

## 14.1 System layout

**INFORMATION**

The following figure is an example and may NOT completely match your system layout.

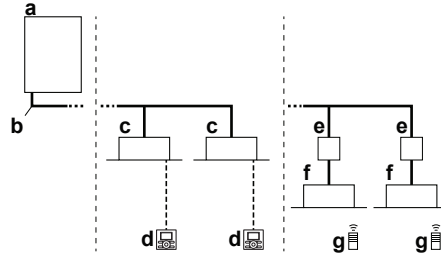

- a** VRV IV-S Heat pump outdoor unit
- b** Refrigerant piping
- c** VRV direct expansion (DX) indoor unit
- d** User interface (dedicated depending on indoor unit type)
- e** BP box (required to connect Residential Air (RA) or Sky Air (SA) direct expansion (DX) indoor units)
- f** Residential Air (RA) direct expansion (DX) indoor units
- g** User interface (wireless, dedicated depending on indoor unit type)



# 15 User interface



## CAUTION

- NEVER touch the internal parts of the controller.
- Do NOT remove the front panel. Some parts inside are dangerous to touch and appliance problems may happen. For checking and adjusting the internal parts, contact your dealer.

This operation manual offers a non-exhaustive overview of the main functions of the system.

Detailed information on required actions to achieve certain functions can be found in the dedicated installation and operation manual of the indoor unit.

Refer to the operation manual of the installed user interface.

# 16 Operation

## In this chapter

16.1	Before operation .....	122
16.2	Operation range.....	123
16.3	Operating the system.....	123
16.3.1	About operating the system .....	123
16.3.2	About cooling, heating, fan only, and automatic operation .....	123
16.3.3	About the heating operation .....	124
16.3.4	To operate the system .....	124
16.4	Using the dry program.....	125
16.4.1	About the dry program .....	125
16.4.2	To use the dry program .....	125
16.5	Adjusting the air flow direction.....	125
16.5.1	About the air flow flap .....	125
16.6	Setting the master user interface .....	126
16.6.1	About setting the master user interface .....	126
16.6.2	To designate the master user interface (VRV DX).....	127
16.6.3	To designate the master user interface (RA DX).....	127
16.6.4	About control systems .....	127

## 16.1 Before operation



### WARNING

This unit contains electrical and hot parts.



### WARNING

Before operating the unit, be sure the installation has been carried out correctly by an installer.



### CAUTION

- NEVER touch the internal parts of the controller.
- Do NOT remove the front panel. Some parts inside are dangerous to touch and appliance problems may happen. For checking and adjusting the internal parts, contact your dealer.



### CAUTION

Do NOT insert fingers, rods or other objects into the air inlet or outlet. Do NOT remove the fan guard. When the fan is rotating at high speed, it will cause injury.



### NOTICE

NEVER inspect or service the unit by yourself. Ask a qualified service person to perform this work.

This operation manual is for the following systems with standard control. Before initiating operation, contact your dealer for the operation that corresponds to your system type and mark. If your installation has a customised control system, ask your dealer for the operation that corresponds to your system.

Operation modes (depending on indoor unit type):

- Heating and cooling (air to air).
- Fan only operation (air to air).

Dedicated functions exist depending on the type of indoor unit, refer to dedicated installation/operation manual for more information.

## 16.2 Operation range

Use the system in the following temperature and humidity ranges for safe and effective operation.

	Cooling	Heating
Outdoor temperature	-5~52°C DB	-20~21°C DB -20~15.5°C WB
Indoor temperature	21~32°C DB 14~25°C WB	15~27°C DB
Indoor humidity	≤80% <sup>(a)</sup>	

<sup>(a)</sup> To avoid condensation and water dripping out of the unit. If the temperature or the humidity is beyond these conditions, safety devices may be put in action and the air conditioner may not operate.

Above operation range is only valid in case direct expansion indoor units are connected to the VRV system.



Special operation ranges are valid in case of using AHU. They can be found in the installation/operation manual of the dedicated unit. Latest information can be found in the technical engineering data.

## 16.3 Operating the system

### 16.3.1 About operating the system

- Operation procedure varies according to the combination of outdoor unit and user interface.
- To protect the unit, turn on the main power switch 6 hours before operation.
- If the main power supply is turned off during operation, operation will restart automatically after the power turns back on again.

### 16.3.2 About cooling, heating, fan only, and automatic operation

- Changeover cannot be made with a user interface whose display shows  "changeover under centralised control" (refer to installation and operation manual of the user interface).
- When the display  "changeover under centralised control" flashes, refer to ["16.6.1 About setting the master user interface"](#) [▶ 126].
- The fan may keep on running for about 1 minute after the heating operation stops.
- The air flow rate may adjust itself depending on the room temperature or the fan may stop immediately. This is not a malfunction.

### 16.3.3 About the heating operation

It may take longer to reach the set temperature for general heating operation than for cooling operation.

The following operation is performed in order to prevent the heating capacity from dropping or cold air from blowing.

#### Defrost operation

In heating operation, freezing of the outdoor unit's air cooled coil increases over time, restricting the energy transfer to the outdoor unit's coil. Heating capability decreases and the system needs to go into defrost operation to be able to remove frost from the outdoor unit's coil. During defrost operation the heating capacity on the indoor unit side will temporarily drop until defrosting is completed. After defrosting, the unit will regain its full heating capacity.

The indoor unit will stop fan operation, the refrigerant cycle will reverse and energy from inside the building will be used to defrost the outdoor unit coil.

The indoor unit will indicate defrost operation on the display .

#### Hot start

In order to prevent cold air from blowing out of an indoor unit at the start of heating operation, the indoor fan is automatically stopped. The display of the user interface shows . It may take some time before the fan starts. This is not a malfunction.



#### INFORMATION

- The heating capacity drops when the outside temperature falls. If this happens, use another heating device together with the unit. (When using together with appliances that produce open fire, ventilate the room constantly). Do not place appliances that produce open fire in places exposed to the air flow from the unit or under the unit.
- It takes some time to heat up the room from the time the unit is started since the unit uses a hot-air circulating system to heat the entire room.
- If the hot air rises to the ceiling, leaving the area above the floor cold, we recommend that you use the circulator (the indoor fan for circulating air). Contact your dealer for details.

### 16.3.4 To operate the system

- 1 Press the operation mode selector button on the user interface several times and select the operation mode of your choice.

 Cooling operation

 Heating operation

 Fan only operation

- 2 Press the ON/OFF button on the user interface.

**Result:** The operation lamp lights up and the system starts operating.

## 16.4 Using the dry program

### 16.4.1 About the dry program

- The function of this program is to decrease the humidity in your room with minimal temperature decrease (minimal room cooling).
- The micro computer automatically determines temperature and fan speed (cannot be set by the user interface).
- The system does not go into operation if the room temperature is low (<20°C).

### 16.4.2 To use the dry program

#### To start

- 1 Press the operation mode selector button on the user interface several times and select  (program dry operation).
- 2 Press the ON/OFF button of the user interface.  
**Result:** The operation lamp lights up and the system starts operating.
- 3 Press the air flow direction adjust button (only for double-flow, multi-flow, corner, ceiling-suspended and wall-mounted). Refer to "[16.5 Adjusting the air flow direction](#)" [▶ 125] for details.

#### To stop

- 4 Press the ON/OFF button on the user interface once again.

**Result:** The operation lamp goes out and the system stops operating.



#### NOTICE

Do not turn off power immediately after the unit stops, but wait for at least 5 minutes.

## 16.5 Adjusting the air flow direction

Refer to the operation manual of the user interface.

### 16.5.1 About the air flow flap

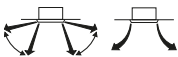
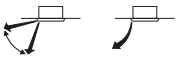
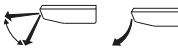
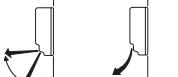

Air flow flap types:

-  Double flow + multi-flow units
-  Corner units
-  Ceiling suspended units
-  Wall-mounted units

For the following conditions, a micro computer controls the air flow direction which may be different from the display.

Cooling	Heating
<ul style="list-style-type: none"> <li>When the room temperature is lower than the set temperature.</li> </ul>	<ul style="list-style-type: none"> <li>When starting operation.</li> <li>When the room temperature is higher than the set temperature.</li> <li>At defrost operation.</li> </ul>
<ul style="list-style-type: none"> <li>When operating continuously at horizontal air flow direction.</li> <li>When continuous operation with downward air flow is performed at the time of cooling with a ceiling-suspended or a wall-mounted unit, the micro computer may control the flow direction, and then the user interface indication will also change.</li> </ul>	

The air flow direction can be adjusted in one of the following ways:

- The air flow flap itself adjusts its position.
- The air flow direction can be fixed by the user.
- Automatic  and desired position .



**WARNING**

NEVER touch the air outlet or the horizontal blades while the swing flap is in operation. Fingers may become caught or the unit may break down.



**NOTICE**

- The movable limit of the flap is changeable. Contact your dealer for details. (only for double-flow, multi-flow, corner, ceiling-suspended and wall-mounted).
- Avoid operating in the horizontal direction . It may cause dew or dust to settle on the ceiling or flap.

## 16.6 Setting the master user interface

### 16.6.1 About setting the master user interface



**INFORMATION**

The following figure is an example and may NOT completely match your system layout.

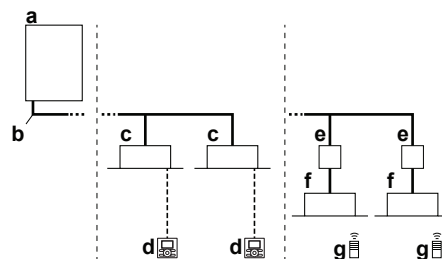

- a** VRV IV-S Heat pump outdoor unit
- b** Refrigerant piping
- c** VRV direct expansion (DX) indoor unit
- d** User interface (dedicated depending on indoor unit type)
- e** BP box (required to connect Residential Air (RA) or Sky Air (SA) direct expansion (DX) indoor units)
- f** Residential Air (RA) direct expansion (DX) indoor units
- g** User interface (wireless, dedicated depending on indoor unit type)

When the system is installed as shown in the figure above, it is necessary to designate one of the user interfaces as the master user interface.

The displays of slave user interfaces show  (changeover under centralised control) and slave user interfaces automatically follow the operation mode directed by the master user interface.

Only the master user interface can select heating or cooling mode (cooling/heating masterhood).



### 16.6.2 To designate the master user interface (VRV DX)

In case only VRV DX indoor units are connected to the VRV system:

- 1 Press the operation mode selector button of the current master user interface for 4 seconds. In case this procedure was not yet performed, the procedure can be executed on the first user interface operated.

**Result:** The display showing  (changeover under centralised control) of all slave user interfaces connected to the same outdoor unit flashes.

- 2 Press the operation mode selector button of the controller that you wish to designate as the master user interface.

**Result:** Designation is completed. This user interface is designated as the master user interface and the display showing  (changeover under centralised control) vanishes. The displays of other user interfaces show  (changeover under centralised control).

### 16.6.3 To designate the master user interface (RA DX)

In case only RA DX indoor units are connected to the VRV IV-S system:

- 1 Stop all indoor units.
- 2 When the system is not operating (all indoor units thermo OFF), you can define the master RA DX indoor unit by addressing that unit with infrared user interface (instruct thermo ON in desired mode).

The only way to change the master unit is by repeating the previous procedure. A cool/heat switchover (or opposite) is only possible by changing the operation mode of the defined master indoor unit.

### 16.6.4 About control systems

This system provides two other control systems beside individual control system (one user interface controls one indoor unit). Confirm the following if your unit is of the following control system type:

Type	Description
Group control system	One user interface controls up to 16 indoor units. All indoor units are equally set.
Two user interface control system	Two user interfaces control one indoor unit (in case of group control system, one group of indoor units). The unit is individually operated.



#### NOTICE

Contact your dealer in case of changing the combination or setting of group control and two user interface control systems.

## 17 Energy saving and optimum operation

Observe the following precautions to ensure the system operates properly.

- Adjust the air outlet properly and avoid direct air flow to room inhabitants.
- Adjust the room temperature properly for a comfortable environment. Avoid excessive heating or cooling.
- Prevent direct sunlight from entering a room during cooling operation by using curtains or blinds.
- Ventilate often. Extended use requires special attention to ventilation.
- Keep doors and windows closed. If the doors and windows remain open, air will flow out of your room causing a decrease in the cooling or heating effect.
- Be careful NOT to cool or heat too much. To save energy, keep the temperature setting at a moderate level.
- NEVER place objects near the air inlet or the air outlet of the unit. Doing so may cause a reduced heating/cooling effect or stop operation.
- Turn off the main power supply switch to the unit when the unit is not used for longer periods of time. If the switch is on, it consumes electricity. Before restarting the unit, turn on the main power supply switch 6 hours before operation to ensure smooth running. (Refer to "Maintenance" in the indoor unit manual.)
- When the display shows  (time to clean the air filter), ask a qualified service person to clean the filters. (Refer to "Maintenance" in the indoor unit manual.)
- Keep the indoor unit and user interface at least 1 m away from televisions, radios, stereos, and other similar equipment. Failing to do so may cause static or distorted pictures.
- Do NOT place items under the indoor unit, as they may be damaged by water.
- Condensation may form if the humidity is above 80% or if the drain outlet gets blocked.

This heat pump system is equipped with advanced energy saving functionality. Depending on the priority, emphasis can be put on energy saving or comfort level. Several parameters can be selected, resulting in the optimal balance between energy consumption and comfort for the particular application.

Several patterns are available and roughly explained below. Contact your installer or dealer for advice or to modify the parameters to the needs of your building.

Detailed information is given for the installer in the installation manual. He can help you to realize the best balance between energy consumption and comfort.



## 17.1 Available main operation methods

### Basic

The refrigerant temperature is fixed independent from the situation.

### Automatic

The refrigerant temperature is set depending on the outdoor ambient conditions. As such adjusting the refrigerant temperature to match the required load (which is also related to the outdoor ambient conditions).

E.g., when your system is operating in cooling, you do not need as much cooling under low outdoor ambient temperatures (e.g., 25°C) as under high outdoor ambient temperatures (e.g., 35°C). Using this idea, the system automatically starts increasing its refrigerant temperature, automatically reducing the delivered capacity and increasing the system's efficiency.

### Hi-sensible/economic (cooling/heating)

The refrigerant temperature is set higher/lower (cooling/heating) compared to basic operation. The focus under high sensible mode is comfort feeling for the customer.

The selection method of indoor units is important and has to be considered as the available capacity is not the same as under basic operation.

For details concerning to Hi-sensible applications, please contact your installer.

## 17.2 Available comfort settings

For each of above modes a comfort level can be selected. The comfort level is related to the timing and the effort (energy consumption) which is put in achieving a certain room temperature by temporarily changing the refrigerant temperature to different values in order to achieve requested conditions more quickly.

- Powerful
- Quick
- Mild
- Eco

# 18 Maintenance and service



**WARNING**

NEVER replace a fuse with a fuse of a wrong ampere ratings or other wires when a fuse blows out. Use of wire or copper wire may cause the unit to break down or cause a fire.



**CAUTION: Pay attention to the fan!**

It is dangerous to inspect the unit while the fan is running.  
Make sure to turn OFF the main switch before executing any maintenance task.



**CAUTION**

Do NOT insert fingers, rods or other objects into the air inlet or outlet. Do NOT remove the fan guard. When the fan is rotating at high speed, it will cause injury.



**CAUTION**

After a long use, check the unit stand and fitting for damage. If damaged, the unit may fall and result in injury.



**NOTICE**

NEVER inspect or service the unit by yourself. Ask a qualified service person to perform this work.



**NOTICE**

Do NOT wipe the controller operation panel with benzene, thinner, chemical dust cloth, etc. The panel may get discoloured or the coating peeled off. If it is heavily dirty, soak a cloth in water-diluted neutral detergent, squeeze it well and wipe the panel clean. Wipe it with another dry cloth.

## In this chapter

18.1	Maintenance after a long stop period .....	130
18.2	Maintenance before a long stop period .....	131
18.3	About the refrigerant .....	131
18.4	After-sales service and warranty .....	131
18.4.1	Warranty period .....	131
18.4.2	Recommended maintenance and inspection .....	132
18.4.3	Recommended maintenance and inspection cycles .....	132
18.4.4	Shortened maintenance and replacement cycles .....	133

## 18.1 Maintenance after a long stop period

E.g., at the beginning of the season.

- Check and remove everything that might be blocking inlet and outlet vents of indoor units and outdoor units.
- Clean air filters and casings of indoor units. Contact your installer or maintenance person to clean air filters and casings of the indoor unit. Maintenance tips and procedures for cleaning are provided in the installation/operation manuals of dedicated indoor units. Make sure to install cleaned air filters back in the same position.

- Turn on the power at least 6 hours before operating the system in order to ensure smoother operation. As soon as the power is turned on, the user interface display appears.

## 18.2 Maintenance before a long stop period

E.g., at the end of the season.

- Let the indoor units run in fan-only operation for about half a day in order to dry the interior of the units. Refer to "[16.3.2 About cooling, heating, fan only, and automatic operation](#)" [▶ 123] for details on fan-only operation.
- Turn off the power. The user interface display disappears.
- Clean air filters and casings of indoor units. Contact your installer or maintenance person to clean air filters and casings of the indoor unit. Maintenance tips and procedures for cleaning are provided in the installation/operation manuals of dedicated indoor units. Make sure to install cleaned air filters back in the same position.

## 18.3 About the refrigerant

This product contains fluorinated greenhouse gases. Do NOT vent gases into the atmosphere.

Refrigerant type: R410A

Global warming potential (GWP) value: 2087.5



### NOTICE

Applicable legislation on **fluorinated greenhouse gases** requires that the refrigerant charge of the unit is indicated both in weight and CO<sub>2</sub> equivalent.

**Formula to calculate the quantity in CO<sub>2</sub> equivalent tonnes:** GWP value of the refrigerant × total refrigerant charge [in kg]/1000

Contact your installer for more information.



### WARNING

- The refrigerant in the system is safe and normally does NOT leak. If the refrigerant leaks in the room, contact with a fire of a burner, a heater or a cooker may result in a harmful gas.
- Turn OFF any combustible heating devices, ventilate the room and contact the dealer where you purchased the unit.
- Do NOT use the system until a service person confirms that the portion where the refrigerant leaks is repaired.

## 18.4 After-sales service and warranty

### 18.4.1 Warranty period

- This product includes a warranty card that was filled in by the dealer at the time of installation. The completed card has to be checked by the customer and stored carefully.

- If repairs to the product are necessary within the warranty period, contact your dealer and keep the warranty card at hand.

#### 18.4.2 Recommended maintenance and inspection

Since dust collects when using the unit for several years, performance of the unit will deteriorate to some extent. As taking apart and cleaning interiors of units requires technical expertise and in order to ensure the best possible maintenance of your units, we recommend to enter into a maintenance and inspection contract on top of normal maintenance activities. Our network of dealers has access to a permanent stock of essential components in order to keep your unit in operation as long as possible. Contact your dealer for more information.

##### When asking your dealer for an intervention, always state:

- The complete model name of the unit.
- The manufacturing number (stated on the nameplate of the unit).
- The installation date.
- The symptoms or malfunction, and details of the defect.



##### WARNING

- Do NOT modify, disassemble, remove, reinstall or repair the unit yourself as incorrect dismantling or installation may cause an electrical shock or fire. Contact your dealer.
- In case of accidental refrigerant leaks, make sure there are no naked flames. The refrigerant itself is entirely safe, non-toxic and non-combustible, but it will generate toxic gas when it accidentally leaks into a room where combustion air from fan heaters, gas cookers, etc. is present. ALWAYS have qualified service personnel confirm that the point of leakage has been repaired or corrected before resuming operation.

#### 18.4.3 Recommended maintenance and inspection cycles

Be aware that the mentioned maintenance and replacement cycles do not relate to the warranty period of the components.

Component	Inspection cycle	Maintenance cycle (replacements and/or repairs)
Electric motor	1 year	20,000 hours
PCB		25,000 hours
Heat exchanger		5 years
Sensor (thermistor, etc.)		5 years
User interface and switches		25,000 hours
Drain pan		8 years
Expansion valve		20,000 hours
Solenoid valve		20,000 hours

The table assumes the following conditions of use:

- Normal use without frequent starting and stopping of the unit. Depending on the model, we recommend not starting and stopping the machine more than 6 times/hour.
- Operation of the unit is assumed to be 10 hours/day and 2,500 hours/year.

**NOTICE**

- The table indicates main components. Refer to your maintenance and inspection contract for more details.
- The table indicates recommended intervals of maintenance cycles. However, in order to keep the unit operational as long as possible, maintenance work may be required sooner. Recommended intervals can be used for appropriate maintenance design in terms of budgeting maintenance and inspection fees. Depending on the content of the maintenance and inspection contract, inspection and maintenance cycles may in reality be shorter than listed.

## 18.4.4 Shortened maintenance and replacement cycles

Shortening of "maintenance cycle" and "replacement cycle" needs to be considered in following situations:

**The unit is used in locations where:**

- Heat and humidity fluctuate out of the ordinary.
- Power fluctuation is high (voltage, frequency, wave distortion, etc.) (the unit cannot be used if power fluctuation is outside the allowable range).
- Bumps and vibrations are frequent.
- Dust, salt, harmful gas or oil mist such as sulphurous acid and hydrogen sulfide may be present in the air.
- The machine is started and stopped frequently or operation time is long (sites with 24 hour air-conditioning).

**Recommended replacement cycle of wear parts**

Component	Inspection cycle	Maintenance cycle (replacements and/or repairs)
Air filter	1 year	5 years
High efficiency filter		1 year
Fuse		10 years
Crankcase heater		8 years
Pressure containing parts		In case of corrosion, contact your local dealer.

**NOTICE**

- The table indicates main components. Refer to your maintenance and inspection contract for more details.
- The table indicates recommended intervals of replacement cycles. However, in order to keep the unit operational as long as possible, maintenance work may be required sooner. Recommended intervals can be used for appropriate maintenance design in terms of budgeting maintenance and inspection fees. Contact your dealer for details.

**INFORMATION**

Damage due to taking apart or cleaning interiors of units by anyone other than our authorised dealers may not be included in the warranty.

# 19 Troubleshooting

If one of the following malfunctions occurs, take the measures shown below and contact your dealer.



## WARNING

**Stop operation and shut OFF the power if anything unusual occurs (burning smells etc.).**

Leaving the unit running under such circumstances may cause breakage, electrical shock or fire. Contact your dealer.

The system **MUST** be repaired by a qualified service person.

Malfunction	Measure
If a safety device such as a fuse, a breaker or an earth leakage breaker frequently actuates or the ON/OFF switch does NOT properly work.	Turn OFF the main power switch.
If water leaks from the unit.	Stop the operation.
The operation switch does NOT work well.	Turn OFF the power supply.
If the user interface display indicates the unit number, the operation lamp flashes and the malfunction code appears.	Notify your installer and report the malfunction code.

If the system does NOT operate properly except for the above mentioned cases and none of the above mentioned malfunctions is evident, investigate the system in accordance with the following procedures.

Malfunction	Measure
If the system does not operate at all.	<ul style="list-style-type: none"> <li>▪ Check if there is no power failure. Wait until power is restored. If power failure occurs during operation, the system automatically restarts immediately after power is restored.</li> <li>▪ Check if no fuse has blown or breaker is activated. Change the fuse or reset the breaker if necessary.</li> </ul>
If the system goes into fan only operation, but as soon as it goes into heating or cooling operation, the system stops.	<ul style="list-style-type: none"> <li>▪ Check if air inlet or outlet of outdoor or indoor unit is not blocked by obstacles. Remove any obstacles and make sure the air can flow freely.</li> <li>▪ Check if the user interface display shows  (time to clean the air filter). (Refer to "<a href="#">18 Maintenance and service</a>" [▶ 130] and "Maintenance" in the indoor unit manual.)</li> </ul>

Malfunction	Measure
The system operates but cooling or heating is insufficient.	<ul style="list-style-type: none"> <li>▪ Check if air inlet or outlet of outdoor or indoor unit is not blocked by obstacles. Remove any obstacles and make sure the air can flow freely.</li> <li>▪ Check if the air filter is not clogged (refer to "Maintenance" in the indoor unit manual).</li> <li>▪ Check the temperature setting.</li> <li>▪ Check the fan speed setting on your user interface.</li> <li>▪ Check for open doors or windows. Close doors and windows to prevent wind from coming in.</li> <li>▪ Check if there are too many occupants in the room during cooling operation. Check if the heat source of the room is excessive.</li> <li>▪ Check if direct sunlight enters the room. Use curtains or blinds.</li> <li>▪ Check if the air flow angle is proper.</li> </ul>

After checking all the items above, if it is impossible to fix the problem yourself, contact your installer and state the symptoms, the complete model name of the unit (with manufacturing number if possible) and the installation date.

## In this chapter

19.1	Error codes: Overview .....	135
19.2	Symptoms that are NOT system malfunctions .....	137
19.2.1	Symptom: The system does not operate .....	138
19.2.2	Symptom: Fan operation is possible, but cooling and heating do not work .....	138
19.2.3	Symptom: The fan speed does not correspond to the setting .....	138
19.2.4	Symptom: The fan direction does not correspond to the setting .....	138
19.2.5	Symptom: White mist comes out of a unit (Indoor unit) .....	138
19.2.6	Symptom: White mist comes out of a unit (Indoor unit, outdoor unit) .....	138
19.2.7	Symptom: The user interface reads "U4" or "U5" and stops, but then restarts after a few minutes .....	139
19.2.8	Symptom: Noise of air conditioners (Indoor unit) .....	139
19.2.9	Symptom: Noise of air conditioners (Indoor unit, outdoor unit) .....	139
19.2.10	Symptom: Noise of air conditioners (Outdoor unit) .....	139
19.2.11	Symptom: Dust comes out of the unit .....	139
19.2.12	Symptom: The units can give off odours .....	139
19.2.13	Symptom: The outdoor unit fan does not spin .....	139
19.2.14	Symptom: The display shows "88" .....	140
19.2.15	Symptom: The compressor in the outdoor unit does not stop after a short heating operation .....	140
19.2.16	Symptom: The inside of an outdoor unit is warm even when the unit has stopped .....	140
19.2.17	Symptom: Hot air can be felt when the indoor unit is stopped .....	140

## 19.1 Error codes: Overview

In case a malfunction code appears on the indoor unit user interface display, contact your installer and inform the malfunction code, the unit type, and serial number (you can find this information on the nameplate of the unit).

For your reference, a list with malfunction codes is provided. You can, depending on the level of the malfunction code, reset the code by pushing the ON/OFF button. If not, ask your installer for advice.

Main code	Contents
<i>RD</i>	External protection device was activated

Main code	Contents
<i>R1</i>	EEPROM failure (indoor)
<i>R3</i>	Drain system malfunction (indoor)
<i>R5</i>	Fan motor malfunction (indoor)
<i>R7</i>	Swing flap motor malfunction (indoor)
<i>R9</i>	Expansion valve malfunction (indoor)
<i>RF</i>	Drain malfunction (indoor unit)
<i>RH</i>	Filter dust chamber malfunction (indoor)
<i>RJ</i>	Capacity setting malfunction (indoor)
<i>C1</i>	Transmission malfunction between main PCB and sub PCB (indoor)
<i>C4</i>	Heat exchanger thermistor malfunction (indoor; liquid)
<i>C5</i>	Heat exchanger thermistor malfunction (indoor; gas)
<i>C9</i>	Suction air thermistor malfunction (indoor)
<i>CR</i>	Discharge air thermistor malfunction (indoor)
<i>CE</i>	Movement detector or floor temperature sensor malfunction (indoor)
<i>CJ</i>	User interface thermistor malfunction (indoor)
<i>E1</i>	PCB malfunction (outdoor)
<i>E2</i>	Current leakage detector was activated (outdoor)
<i>E3</i>	High pressure switch was activated
<i>E4</i>	Low pressure malfunction (outdoor)
<i>E5</i>	Compressor lock detection (outdoor)
<i>E7</i>	Fan motor malfunction (outdoor)
<i>E9</i>	Electronic expansion valve malfunction (outdoor)
<i>F3</i>	Discharge temperature malfunction (outdoor)
<i>F4</i>	Abnormal suction temperature (outdoor)
<i>F5</i>	Refrigerant overcharge detection
<i>H3</i>	High pressure switch malfunction
<i>H4</i>	Low pressure switch malfunction
<i>H7</i>	Fan motor trouble (outdoor)
<i>H9</i>	Ambient temperature sensor malfunction (outdoor)
<i>J1</i>	Pressure sensor malfunction
<i>J2</i>	Current sensor malfunction
<i>J3</i>	Discharge temperature sensor malfunction (outdoor)
<i>J4</i>	Heat exchanger gas temperature sensor malfunction (outdoor)
<i>J5</i>	Suction temperature sensor malfunction (outdoor)
<i>J6</i>	De-icing temperature sensor malfunction (outdoor)



Main code	Contents
J7	Liquid temperature sensor (after subcool HE) malfunction (outdoor)
J8	Liquid temperature sensor (coil) malfunction (outdoor)
J9	Gas temperature sensor (after subcool HE) malfunction (outdoor)
JA	High pressure sensor malfunction (S1NPH)
JC	Low pressure sensor malfunction (S1NPL)
L1	INV PCB abnormal
L4	Fin temperature abnormal
L5	Inverter PCB faulty
LB	Compressor over current detected
L9	Compressor lock (startup)
LC	Transmission outdoor unit - inverter: INV transmission trouble
P1	INV unbalanced power supply voltage
P4	Fin thermistor malfunction
PJ	Capacity setting malfunction (outdoor)
UD	Abnormal low pressure drop, faulty expansion valve
U1	Reversed power supply phase malfunction
U2	INV voltage power shortage
U3	System test run not yet executed
U4	Faulty wiring indoor/outdoor
U5	Abnormal user interface - indoor communication
U7	Faulty wiring to outdoor/outdoor
UB	Abnormal main-sub user interface communication
U9	System mismatch. Wrong type of indoor units combined. Indoor unit malfunction.
UA	Connection malfunction over indoor units or type mismatch
UC	Centralised address duplication
UE	Malfunction in communication centralised control device - indoor unit
UF	Auto address malfunction (inconsistency)
UH	Auto address malfunction (inconsistency)

## 19.2 Symptoms that are NOT system malfunctions

The following symptoms are NOT system malfunctions:

### 19.2.1 Symptom: The system does not operate

- The air conditioner does not start immediately after the ON/OFF button on the user interface is pressed. If the operation lamp lights, the system is in normal condition. To prevent overloading of the compressor motor, the air conditioner starts 5 minutes after it is turned ON again in case it was turned OFF just before. The same starting delay occurs after the operation mode selector button was used.
- If "Under Centralised Control" is displayed on the user interface, pressing the operation button causes the display to blink for a few seconds. The blinking display indicates that the user interface cannot be used.
- The system does not start immediately after the power supply is turned on. Wait one minute until the microcomputer is prepared for operation.

### 19.2.2 Symptom: Fan operation is possible, but cooling and heating do not work

Immediately after the power is turned on. The micro computer is getting ready to operate and is performing a communication check with all indoor units. Please wait 12 minutes maximally until this process is finished.

### 19.2.3 Symptom: The fan speed does not correspond to the setting

The fan speed does not change even if the fan speed adjustment button is pressed. During heating operation, when the room temperature reaches the set temperature, the outdoor unit goes off and the indoor unit changes to whisper fan speed. This is to prevent cold air blowing directly on occupants of the room. The fan speed will not change even when another indoor unit is in heating operation, if the button is pressed.

### 19.2.4 Symptom: The fan direction does not correspond to the setting

The fan direction does not correspond with the user interface display. The fan direction does not swing. This is because the unit is being controlled by the micro computer.

### 19.2.5 Symptom: White mist comes out of a unit (Indoor unit)

- When humidity is high during cooling operation. If the interior of an indoor unit is extremely contaminated, the temperature distribution inside a room becomes uneven. It is necessary to clean the interior of the indoor unit. Ask your dealer for details on cleaning the unit. This operation requires a qualified service person.
- Immediately after the cooling operation stops and if the room temperature and humidity are low. This is because warm refrigerant gas flows back into the indoor unit and generates steam.

### 19.2.6 Symptom: White mist comes out of a unit (Indoor unit, outdoor unit)

When the system is changed over to heating operation after defrost operation. Moisture generated by defrost becomes steam and is exhausted.

### 19.2.7 Symptom: The user interface reads "U4" or "U5" and stops, but then restarts after a few minutes

This is because the user interface is intercepting noise from electric appliances other than the air conditioner. The noise prevents communication between the units, causing them to stop. Operation automatically restarts when the noise ceases. A power reset may help to remove this error.

### 19.2.8 Symptom: Noise of air conditioners (Indoor unit)

- A "zeen" sound is heard immediately after the power supply is turned on. The electronic expansion valve inside an indoor unit starts working and makes the noise. Its volume will reduce in about one minute.
- A continuous low "shah" sound is heard when the system is in cooling operation or at a stop. When the drain pump (optional accessories) is in operation, this noise is heard.
- A "pishi-pishi" squeaking sound is heard when the system stops after heating operation. Expansion and contraction of plastic parts caused by temperature change make this noise.
- A low "sah", "choro-choro" sound is heard while the indoor unit is stopped. When another indoor unit is in operation, this noise is heard. In order to prevent oil and refrigerant from remaining in the system, a small amount of refrigerant is kept flowing.

### 19.2.9 Symptom: Noise of air conditioners (Indoor unit, outdoor unit)

- A continuous low hissing sound is heard when the system is in cooling or defrost operation. This is the sound of refrigerant gas flowing through both indoor and outdoor units.
- A hissing sound which is heard at the start or immediately after stopping operation or defrost operation. This is the noise of refrigerant caused by flow stop or flow change.

### 19.2.10 Symptom: Noise of air conditioners (Outdoor unit)

When the tone of operating noise changes. This noise is caused by the change of frequency.

### 19.2.11 Symptom: Dust comes out of the unit

When the unit is used for the first time in a long time. This is because dust has gotten into the unit.

### 19.2.12 Symptom: The units can give off odours

The unit can absorb the smell of rooms, furniture, cigarettes, etc., and then emit it again.

### 19.2.13 Symptom: The outdoor unit fan does not spin

During operation, the speed of the fan is controlled in order to optimise product operation.

### 19.2.14 Symptom: The display shows "88"

This is the case immediately after the main power supply switch is turned on and means that the user interface is in normal condition. This continues for 1 minute.

### 19.2.15 Symptom: The compressor in the outdoor unit does not stop after a short heating operation

This is to prevent refrigerant from remaining in the compressor. The unit will stop after 5 to 10 minutes.

### 19.2.16 Symptom: The inside of an outdoor unit is warm even when the unit has stopped

This is because the crankcase heater is warming the compressor so that the compressor can start smoothly.

### 19.2.17 Symptom: Hot air can be felt when the indoor unit is stopped

Several different indoor units are being run on the same system. When another unit is running, some refrigerant will still flow through the unit.

## 20 Relocation

Contact your dealer to remove and reinstall the entire unit. Moving units requires technical expertise.

## 21 Disposal

This unit uses hydrofluorocarbon. Contact your dealer when discarding this unit. It is required by law to collect, transport and discard the refrigerant in accordance with the "hydrofluorocarbon collection and destruction" regulations.



### **NOTICE**

Do NOT try to dismantle the system yourself: dismantling of the system, treatment of the refrigerant, oil and other parts **MUST** comply with applicable legislation. Units **MUST** be treated at a specialised treatment facility for reuse, recycling and recovery.

## 22 Glossary

**Dealer**

Sales distributor for the product.

**Authorised installer**

Technical skilled person who is qualified to install the product.

**User**

Person who is owner of the product and/or operates the product.

**Applicable legislation**

All international, European, national and local directives, laws, regulations and/or codes that are relevant and applicable for a certain product or domain.

**Service company**

Qualified company which can perform or coordinate the required service to the product.

**Installation manual**

Instruction manual specified for a certain product or application, explaining how to install, configure and maintain it.

**Operation manual**

Instruction manual specified for a certain product or application, explaining how to operate it.

**Maintenance instructions**

Instruction manual specified for a certain product or application, which explains (if relevant) how to install, configure, operate and/or maintain the product or application.

**Accessories**

Labels, manuals, information sheets and equipment that are delivered with the product and that need to be installed according to the instructions in the accompanying documentation.

**Optional equipment**

Equipment made or approved by Daikin that can be combined with the product according to the instructions in the accompanying documentation.

**Field supply**

Equipment NOT made by Daikin that can be combined with the product according to the instructions in the accompanying documentation.

ERC